

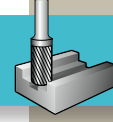





CARBIDE BURS







SERT METAL ÇAPAK ALMA FREZELERİ







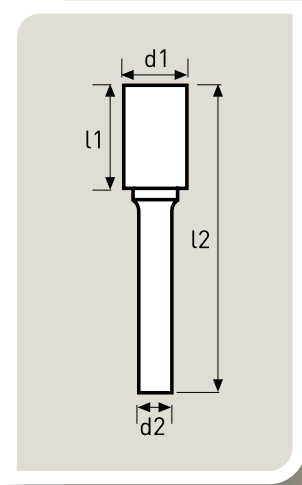

Cylinder with end cut / Silindir Alın Kesicili

				
d1 Dia/Çap	6	6	6	8
l1	19	19	25	19
d2	6	6	6	6
l2	50	75	50	65
 Standard Cut Düz Kanallı	T1402	T1402L		T1502
EURO	12.30	15.10		14.50
 Double Cut Talaş Kırıcılı	T1402D	T1402DL	T1402D-1	T1502D
EURO	12.30	15.10	13.10	14.50



				
d1 Dia/Çap	10	10	11	12
l1	19	25	25	19
d2	6	6	6	6
l2	65	70	70	65
 Standard Cut Düz Kanallı	T1602			T1702
EURO	15.80			21.90
 Double Cut Talaş Kırıcılı	TDX162	T1602D-1	T1652D	T1702D
EURO	15.80	16.50	17.00	21.90



				
d1 Dia/Çap	12	12	16	16
l1	25	25	25	25
d2	6	8	6	8
l2	70	70	70	70
 Standard Cut Düz Kanallı	T1702-1	T1702-1-8	T1802-6	T1802
EURO	22.40	22.40	30.30	30.30
 Double Cut Talaş Kırıcılı	TDX172-1	T1702D-1-8	T1802D-6	T1802D
EURO	22.40	22.40	30.30	30.30