

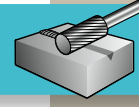



CARBIDE BURS ALUMINIUM CUT
SERT METAL ÇAPAK ALMA FREZELERİ ALUMİNYUM İÇİN





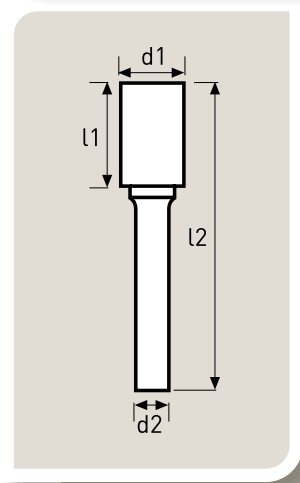
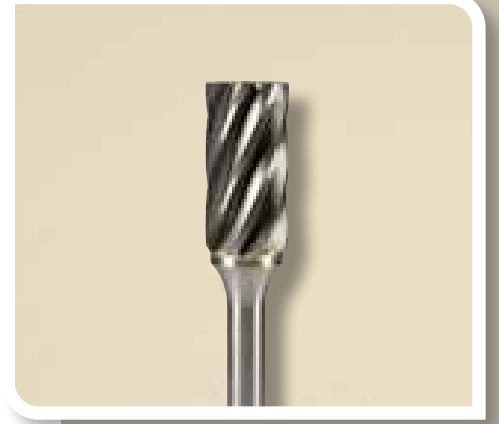

Cylinder without end cut / Silindir Düz Uçlu

				
d1 Dia/Çap	6	10	12	16
l1	19	19	25	25
d2	6	6	6	8
l2	50	65	70	70
Aluminium Cut Alüminyum Kanal	TTA240	TTA260	TTA270	TTA280
EURO	17.20	22.30	23.00	38.00

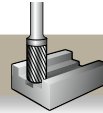

Cylinder with end cut / Silindir Alın Kesicili



				
d1 Dia/Çap	6	10	12	16
l1	19	19	25	25
d2	6	6	6	8
l2	50	65	70	70
Aluminium Cut Alüminyum Kanal	TTA140	TTA160	TTA170	TTA180
EURO	17.60	23.30	32.70	40.70

