



zeus Knurling Technology
zeus Marking Technology
zeus Burnishing Technology



Catalogue 2022



Hommel+Keller
Film new building 2020

As a global leader in knurling technology Hommel+Keller manufactures products of superior quality based on decades of experience, always with the incentive of continuous improvement. Our brand "zeus" is known worldwide, it looks back on a long and proud history and is tailored to the requirements of our customers.



Our zeus product range

offers tooling solutions for a wide range of applications in the field of knurling, marking and burnishing technology. With zeus precision tools, we offer high-quality and durable products. In this catalogue we present the zeus standard program. Most of the tools and knurling wheels shown are available from stock.

zeus Knurling tools

In addition to standardized profiles, zeus knurling tools can also be used to produce conical, convex, concave and special profiles (e.g. beaded knurls). The most important applications for producing profiles on a workpiece are shown in the adjacent application example.

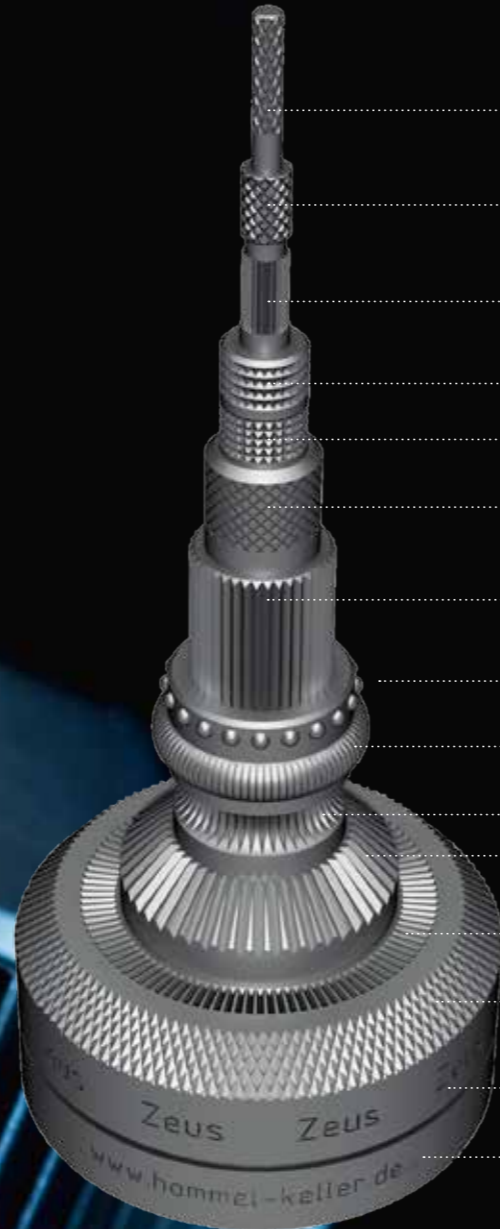

Application	Profile (DIN 82) Marking	Tool Examples	Knurling wheels/ marking rolls
Cut knurling, axial	RGE30°	291	3x AA
Cut knurling, axial	RGE45°	241	1x BL15° 1x BR15°
Cut knurling, axial	RAA	231	1x BR30°
Form knurling, radial	RKV	131	1x KE
Form knurling, radial	RKE	132	1x KV
Form knurling, radial	RGE45°	141	1x BL45° 1x BR45°
Form knurling, radial + axial up to a shoulder	RAA	162	2x AA
Perl radial	RHE	131	1x HV
Form knurling, radial	RE	131	1x C
Form knurling, radial	RC	131	1x E
Form knurling radial	RKAA	311	1x KAA
Form knurling, axial	RAA-face	311	1x AA
Form knurling	RKGV	311	1x KGE
Continuous roll marking	zeus	130	40 W
Spring return marking	hommel+keller.de	431	41 W

The profiles with 45° are standard on Hommel+Keller Präzisionswerkzeuge GmbH but not defined in DIN 403 and DIN 82.

CONTENT

zeus Knurling Technology

Productfinder zeus knurling tools	4
Overview zeus form knurling tools	6
zeus form knurling tools 131 / 132	8
zeus form knurling tools 141	10
zeus form knurling tools 142	12
zeus form knurling tools 161	14
zeus form knurling tools 162	16
zeus form knurling tools Sets	18
Overview zeus cut knurling tools	20
zeus cut knurling tools 231	22
zeus cut knurling tools 241	23
zeus cut knurling tools Sets	24
zeus knurling tools with interchangeable jaws	
291 / 191 / 192	26
Special variants zeus knurling tools	29
zeus knurling wheels	34
zeus knurling wheels forming	35
zeus knurling wheels cutting	39
zeus special knurling wheels	42

zeus Marking Technology

Application example	45
Overview zeus marking tools	46
zeus marking tool 432 / marking segment no. 43	48
zeus marking tool 431 / marking segment no. 41	50
zeus marking tool 422 / 421 / marking roll no. 41	52
zeus marking tool 131 / 311 / 312 / marking roll no. 40	54

zeus Burnishing Technology

zeus burnishing tool 510 / diamond burnishing tips	58
zeus burnishing tool 520 / diamond burnishing tips	59
zeus burnishing rolls	60

Technical information knurling technology

Characteristics	62
Surface treatment	62
Profiles and knurling pitches	63
Conversion to inches	64
Process characteristics (DIN 82)	65
Material displacement – non-cutting forming	66
Reference values for cutting speed and feed rate	67
Influencing factors	68
Optimization of knurling	70

Technical information marking technology

Reference values for process parameters	73
Technical specifications	74



KNURLING TOOLS

PRODUCTFINDER

In knurling technology

there are two different processes:

cut knurling and **form knurling**.

Both processes have their special applications and areas of utilisation.

Application recommendation cut knurling

131:

High process stability
User-friendly handling

161:

High process stability
for long workpieces

Application recommendation cut knurling

241:

Perfect for challenging
visual knurling

Profile on the workpiece		RAA	RBL / RBR	RGE	RGV	RKE	RKV
Form knurling		Tool selection form knurling					
	Knurling on workpiece centre / without plunge cut		131 141 161	131 (E) 141 161	131 (E)		
	Knurling starting at workpiece beginning		131 141 161 191 391	131 (E) 141 161 191 391			
	Knurling starting on workpiece centre / without plunge cut		131 141 161	131 (E) 141 161			
	Knurling starting at workpiece centre up to a shoulder		132 142 162	132 (E) 142 162	132 (E)		
	Knurling starting at workpiece beginning up to a shoulder		132 142 162 192	132 (E) 142 162 192			
	Conical knurling		311 312 161	161	311 312	—	—
	Knurling in a bore		330 332	330 (E) 332 (E) 342	330 (E) 332 (E)		
Cut knurling		Tool selection cut knurling					
	Knurling starting at workpiece beginning	231	231 Note installation See RW231 (P. 22)	241 291	—	—	—
	Knurling starting on workpiece centre / after plunge cut			241	—	—	—

(E) = only plunge cut possible

Possible knurling profiles on the workpiece:

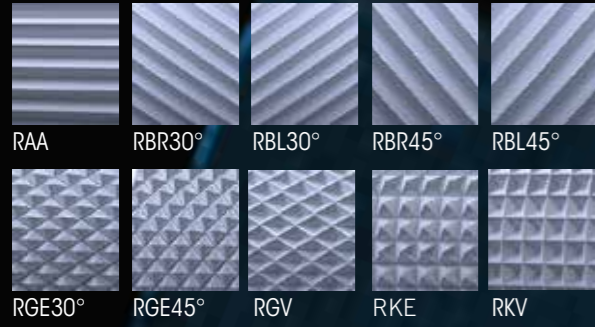

FORM KNURLING

With form knurling the surface of the workpiece is formed chipless. Cold forming is used to shape the material, which limits its use to materials that are suitable for cold forming.







ADDED VALUES

- machining of the workpiece by cold forming, which compresses the surface of the workpiece
- knurling is possible up to a workpiece shoulder
- all knurling profiles according to DIN 82 can be produced
- knurling is possible at any position on the workpiece
- internal and face knurling is possible
- conical knurling is possible

OVERVIEW OF FORM KNURLING TOOLS

With the product finder for form knurling tools you can find your desired product faster. You receive all relevant tool data, as well as possible profiles, the corresponding knurling wheels and the possible direction of machining at a glance.



Tool series	Work-piece Ø [mm]	Profile on workpiece	Profile on knurling wheel	Shank [mm]	Knurling wheel Ø [mm]	Knurling	Knurling profiles						
							RAA	RBL	RBR	RGE	RGV	RKE	RKV
 131 (P.8)	3 – 50	RAA RBR30° RBL30° RBR45° RBL45° RGE30° RGE45° RGV30° RGV45° RKE RKV	AA BL30° BR30° BL45° BR45° GV30° GV45° GE30° GE45° KV KE	10 / 12 / 16	10 / 15	Workpiece center / without plunge cut (radial) Knurling starting at workpiece beginning Knurling starting on workpiece centre / after plunge cut Knurling starting on workpiece centre / without plunge cut Up to a shoulder Knurling starting at workpiece beginning up to a shoulder	●	●	●	●	●	●	●
	8 – 200			20 / 25	20 / 25		–	–	–	–	–	–	–
 132 (P.9)	3 – 50	RAA RBR30° RBL30° RBR45° RBL45° RGE30° RGE45° RGV30° RGV45° RKE RKV	AA BL30° BR30° BL45° BR45° GV30° GV45° GE30° GE45° KV KE	10 / 12 / 16	15	Workpiece center / without plunge cut (radial) Knurling starting at workpiece beginning Knurling starting on workpiece centre / after plunge cut Knurling starting on workpiece centre / without plunge cut Up to a shoulder Knurling starting at workpiece beginning up to a shoulder	●	●	●	●	●	●	●
	8 – 200			20 / 25	20		●	●	●	●	●	●	●
 141 (P.10)	3 – 25	RAA RBR30° RBL30° RBR45° RBL45° RGE30°	2x AA 2x BL30° 2x BR30° 2x BL45° 2x BR45° 1x BR30° + 1x BL30° 1x BR45° + 1x BL45°	10 / 12	10	Workpiece center / without plunge cut (radial) Knurling starting at workpiece beginning Knurling starting on workpiece centre / after plunge cut Knurling starting on workpiece centre / without plunge cut Up to a shoulder Knurling starting at workpiece beginning up to a shoulder	●	●	●	●	–	–	–
	3 – 50			16	15 / 20		●	●	●	●	–	–	–
	6 – 60			20 / 25	20		●	●	●	●	–	–	–
	10 – 110			25	25		–	–	–	–	–	–	–
 142 (P.12)	3 – 40	RAA RBR30° RBL30° RBR45° RBL45° RGE30°	2x AA 2x BL30° 2x BR30° 2x BL45° 2x BR45° 1x BR30° + 1x BL30° 1x BR45° + 1x BL45°	10 / 12 / 16	15	Workpiece center / without plunge cut (radial) Knurling starting at workpiece beginning Knurling starting on workpiece centre / after plunge cut Knurling starting on workpiece centre / without plunge cut Up to a shoulder Knurling starting at workpiece beginning up to a shoulder	●	●	●	●	–	–	–
	10 – 110			20 / 25	20		●	●	●	●	–	–	–
 161 (P.14)	0 – 12.5 0 – 15	RAA RBR30° RBL30° RBR45° RBL45° RGE30°	2x AA 2x BL30° 2x BR30° 2x BL45° 2x BR45° 1x BR30° + 1x BL30° 1x BR45° + 1x BL45°	10 / 12 / 16	10 / 15	Workpiece center / without plunge cut (radial) Knurling starting at workpiece beginning Knurling starting on workpiece centre / after plunge cut Knurling starting on workpiece centre / without plunge cut Up to a shoulder Knurling starting at workpiece beginning up to a shoulder	●	●	●	●	–	–	–
	0 – 65			20 / 25	20 / 25		–	–	–	–	–	–	–
 162 (P.16)	0 – 15	RAA RBR30° RBL30° RBR45° RBL45° RGE30°	2x AA 2x BL30° 2x BR30° 2x BL45° 2x BR45° 1x BR30° + 1x BL30° 1x BR45° + 1x BL45°	10 / 12 / 16	15	Workpiece center / without plunge cut (radial) Knurling starting at workpiece beginning Knurling starting on workpiece centre / after plunge cut Knurling starting on workpiece centre / without plunge cut Up to a shoulder Knurling starting at workpiece beginning up to a shoulder	●	●	●	●	–	–	–
	3.5 – 65			20	20		●	●	●	●	–	–	–



FORM KNURLING TOOLS

Series 131



Ideal for all knurling profiles, features exceptionally easy handling

Knurling profiles on workpiece (DIN 82):

Plunge knurling



Feed knurling



Selection of knurling wheels:



Product features:

- All holders equipped with Click-Pin® system – for fast retooling of the knurling wheels
- Set screws in shank for clearance angle correction
- Carbide pin

TOOL VERSIONS / SPARE PARTS:

Available from stock

Item no. (right-hand version)	Item no. (left-hand version)	Model	Knurling wheel (Ø x w x b) [mm]	Workpiece Ø [mm]	Item no. Pin
31013703 <input checked="" type="checkbox"/>	31013704	131-08	10 / 15 x 4 x 4	3 – 50	06TER1015
31002706 <input checked="" type="checkbox"/>	31002709 <input checked="" type="checkbox"/>	131-10	10 / 15 x 4 x 4	3 – 50	06TER1015
31013690 <input checked="" type="checkbox"/>	31013691	131-10	15 x 6 x 4	3 – 50	06TER1036
31002707 <input checked="" type="checkbox"/>	31002710 <input checked="" type="checkbox"/>	131-12	10 / 15 x 4 x 4	3 – 50	06TER1015
31013692 <input checked="" type="checkbox"/>	31013693	131-12	20 / 25 x 6 x 6	8 – 200	06TER1018
31013694 <input checked="" type="checkbox"/>	31013695	131-12	20 / 25 x 8 x 6	8 – 200	06TER1018
31013696 <input checked="" type="checkbox"/>	31013697	131-14	10 / 15 x 6 x 4	3 – 50	06TER1036
31013698 <input checked="" type="checkbox"/>	31013699	131-14	20 / 25 x 6 x 6	8 – 200	06TER1018
31002708 <input checked="" type="checkbox"/>	31002711 <input checked="" type="checkbox"/>	131-16	10 / 15 x 4 x 4	3 – 50	06TER1036
31013700 <input checked="" type="checkbox"/>	31013701	131-16	20 / 25 x 6 x 6	8 – 200	06TER1018
31003646 <input checked="" type="checkbox"/>	31003647 <input checked="" type="checkbox"/>	131-16	20 / 25 x 8 x 6	8 – 200	06TER1018
	31000714 <input checked="" type="checkbox"/>	131-20	20 / 25 x 8 x 6	8 – 200	06TER1018
	31013702 <input checked="" type="checkbox"/>	131-20	20 / 25 x 10 x 6	8 – 200	06TER1018
	31000715 <input checked="" type="checkbox"/>	131-25	20 / 25 x 8 x 6	8 – 200	06TER1018

Item no. (right-hand version)	Item no. (left-hand version)	Dimensions [mm]						
		a	b	c	d	e	f	x
31013703	31013704	8	8	99	12	19	15.5	1.5/4
31002706	31002709	10	10	99	12	19	17.5	1.5/4
31013690	31013691	10	10	99	16	19	17.5	1.5/4
31002707	31002710	12	12	99	12	19	19.5	1.5/4
31013692	31013693	12	12	109.5	20	29.5	24.5	3/5.5
31013694	31013695	12	12	109.5	20	29.5	24.5	3/5.5
31013696	31013697	14	14	99	16	19	21.5	1.5/4
31013698	31013699	14	14	109.5	20	29.5	26.5	3/5.5
31002708	31002711	16	16	99	16	19	23.5	4
31013700	31013701	16	16	109.5	20	29.5	28.5	3/5.5
31003646	31003647	16	16	113.5	20	33.5	28.5	6.5

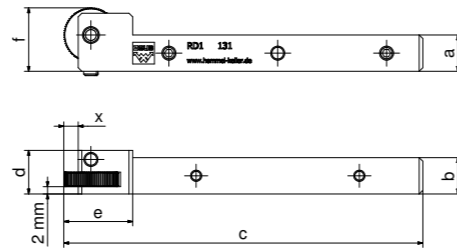

Item no.	Dimensions [mm]						
	a	b	c	d	e	f	x
31000714	20	20	109.5	20	29.5	32.5	3/5.5
31013702	20	20	109.5	20	29.5	32.5	3/5.5
31000715	25	20	109.5	20	29.5	37.5	3/5.5

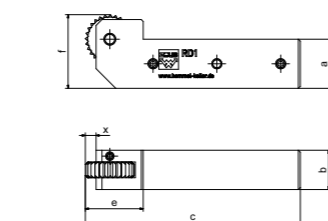

FORM KNURLING TOOLS

Series 132



Ideal for all knurling profiles and applications up to a shoulder

Knurling profiles on workpiece (DIN 82):

Plunge knurling



Feed knurling



Selection of knurling wheels:



Product features:

- Knurling wheel fixed by means of carbide bolt
- Set screws in shank for clearance angle correction
- Modular shank design: Shank size 10 x 10 mm optionally adaptable

TOOL VERSIONS / SPARE PARTS:

Available from stock

Item no. (right-hand version)	Item no. (left-hand version)	Model	Knurling wheel (Ø x w x b) [mm]	Workpiece Ø [mm]	Item no. Pin	Item no. Washer	Item no. Grub screw
31002726 <input checked="" type="checkbox"/>	31002727 <input checked="" type="checkbox"/>	132-10	15 x 6 x 6A11	3 – 50	06TER0444	21BHR0375	06TER2147
31002227 <input checked="" type="checkbox"/>	31002728 <input checked="" type="checkbox"/>	132-12	15 x 6 x 6A11	3 – 50	06TER0444	21BHR0375	06TER2147
31002729 <input checked="" type="checkbox"/>	31002730 <input checked="" type="checkbox"/>	132-16	15 x 6 x 6A11	3 – 50	06TER0444	21BHR0375	06TER2147
	31000742 <input checked="" type="checkbox"/>	132-20	20 x 8 x 6A13	8 – 200	06TER0445	21BHR0380	06TER2101
	31000743 <input checked="" type="checkbox"/>	132-25	20 x 8 x 6A13	8 – 200	06TER0445	21BHR0380	06TER2101

Item no. (right-hand version)	Item no. (left-hand version)	Dimensions [mm]						
		a	b	c	d	e	f	x
31002726	31002727	10	10	101	19	21	18	1.5
31002227	31002728	12	12	101	19	21	20	1.5
31002729	31002730	16	16	101	19	21	24	1.5

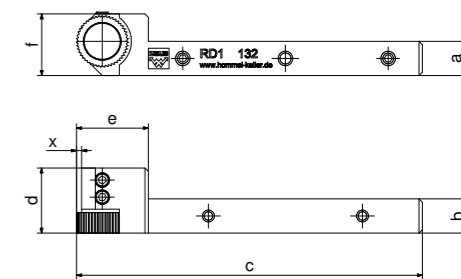

Item no.	Dimensions [mm]						
	a	b	c	d	e	f	x
31000742	20	20	105.3	26.5	25.3	30	1.3
31000743	25	20	105.3	26.5	25.3	35	1.3

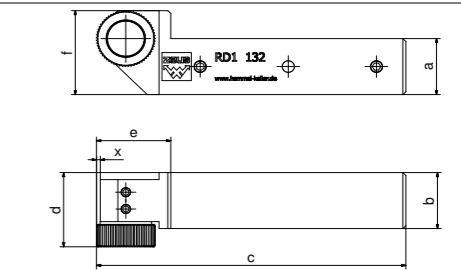



FORM KNURLING TOOLS

Series 141



Excellent for axial profiling,
features flexible centring

Knurling profiles on workpiece (DIN 82):

Plunge / feed knurling



Selection of knurling wheels:

2x AA	2x BR	2x BL	1x BL / 1x BR
-------	-------	-------	------------------

Product features:

- Shank size 20 x 20 mm and 25 x 25 mm with Click-Pin® system – for fast retooling of the knurling wheels
- Modular design: Tool can be used as right-hand and left-hand version
- Knurling head with flexible centring
- Set screws in shank for clearance angle correction
- Carbide pins
- LD = Model for Swiss type lathes

Available from stock

TOOL VERSIONS / SPARE PARTS:

Item no.	Model	Knurling wheel (Ø x w x b) [mm]	Workpiece Ø [mm]	Item no. Pin	Item no. Grub screw	Item no. Knurling head
31013761 <input checked="" type="checkbox"/>	141-10-LD	10 x 4 x 4	3 – 25	06TER0960	06TER2154	21BHR0528
31013762 <input checked="" type="checkbox"/>	141-12-LD	10 x 4 x 4	3 – 25	06TER0960	06TER2154	21BHR0528
31013763 <input checked="" type="checkbox"/>	141-16-LD	15 x 4 x 4	3 – 50	06TER0964	06TER2154	21BHR9779
31002702 <input checked="" type="checkbox"/>	141-10	10 x 4 x 4	3 – 25	06TER0960	06TER2154	21BHR0528
31002703 <input checked="" type="checkbox"/>	141-12	10 x 4 x 4	3 – 25	06TER0960	06TER2154	21BHR0528
31002658 <input checked="" type="checkbox"/>	141-16	15 x 4 x 4	6 – 60	06TER0964	06TER2155	21BHR1791
31000741 <input checked="" type="checkbox"/>	141-16	15 x 6 x 4	6 – 60	06TER0964	06TER2155	21BHR0529
31003648 <input checked="" type="checkbox"/>	141-16	20 x 8 x 6	10 – 110	06TER1018	06TER1016	21BHR1795
31002704 <input checked="" type="checkbox"/>	141-20	20 x 8 x 6	10 – 110	06TER1018	06TER1016	21BHR1795
31002705 <input checked="" type="checkbox"/>	141-25	20 x 8 x 6	10 – 110	06TER1018	06TER1016	21BHR1795
31002721 <input checked="" type="checkbox"/>	141-25	25 x 8 x 6	15 – 220	06TER1018	06TER1016	21BHR1796

Tools of series 141 can be converted to series 142 and vice versa by replacing the knurling head.

APPLICATION EXAMPLE

Series 141 | PROFILE RGE



PROFILE RGE45°

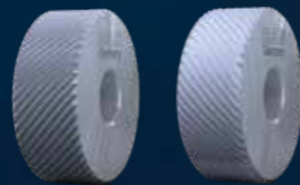

Series 141 | KNURLING HEAD WITH FLEXIBLE CENTRING

KNURLING WHEELS: 1x BL45°, 1x BR45°



FORM KNURLING TOOLS

Series 141



Item no.	Dimensions [mm]						
	a	b	c	d	e	f	x
31013761	10	14	125.5	12	25.5	21	1
31013762	12	14	125.5	12	25.5	21	1
31013763	16	16	135	16	32.5	30.4	2.5

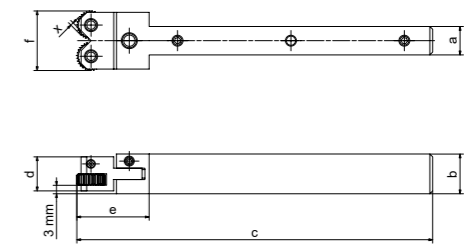

Item no.	Dimensions [mm]						
	a	b	c	d	e	f	x
31002702	10	10	105.5	12	25.5	21	1
31002703	12	12	105.5	12	25.5	22.5	1
31002658	16	16	119	16	39	33	1.5
31000741	16	16	119	16	39	33	1.5

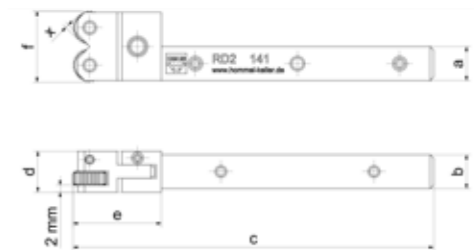

Item no.	Dimensions [mm]						
	a	b	c	d	e	f	x
31003648	16	16	130	20	50	42	2.5
31002704	20	20	130	20	50	42	2.5
31002705	25	20	130	20	50	46	2.5
31002721	25	20	136	20	56	55	2.5

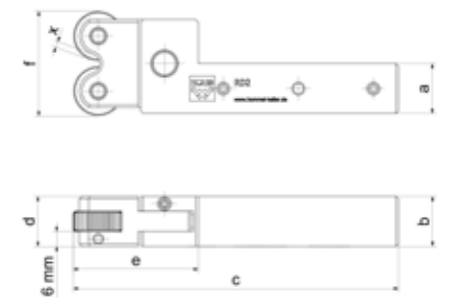



FORM KNURLING TOOLS

Series 142



Excellent for all axial profiling and applications up to a shoulder

Knurling profiles on workpiece (DIN 82):

Plunge / feed knurling



Selection of knurling wheels:



Product features:

- Knurling wheels fixed by means of carbide bolt
- Modular design: Tool can be used as right-hand and left-hand version. Retooling by simply turning the knurling head
- Knurling head with flexible centring
- Set screws in shank for clearance angle correction
- LD = Model for Swiss type lathes

TOOL VERSIONS / SPARE PARTS:

Available from stock

Item no.	Model	Knurling wheel (Ø x w x b) [mm]	Workpiece Ø [mm]	Item no. Pin	Item no. Grub screw	Item no. Washer	Item no. Knurling head
31003957 <input checked="" type="checkbox"/>	142-10-LD	15 x 6 x 6A11	3 – 40	06TER0444	06TER2154	21BHR0375	21BHR9778
31003958 <input checked="" type="checkbox"/>	142-12-LD	15 x 6 x 6A11	3 – 40	06TER0444	06TER2154	21BHR0375	21BHR9778
31003959 <input checked="" type="checkbox"/>	142-16-LD	15 x 6 x 6A11	3 – 40	06TER0444	06TER2154	21BHR0375	21BHR9778
31002801 <input checked="" type="checkbox"/>	142-10	15 x 6 x 6A11	3 – 40	06TER0444	06TER2154	21BHR0375	21BHR1797
31002803 <input checked="" type="checkbox"/>	142-12	15 x 6 x 6A11	3 – 40	06TER0444	06TER2154	21BHR0375	21BHR1797
31000751 <input checked="" type="checkbox"/>	142-16	15 x 6 x 6A11	10 – 110	06TER0444	06TER2154	21BHR0375	21BHR0532
31000752 <input checked="" type="checkbox"/>	142-20	20 x 8 x 6A13	10 – 110	06TER0445	06TER2147	21BHR0380	21BHR0533
31000753 <input checked="" type="checkbox"/>	142-25	20 x 8 x 6A13	10 – 110	06TER0445	06TER2147	21BHR0380	21BHR0533

Tools of series 142 can be converted to series 141 and vice versa by replacing the knurling head.



FORM KNURLING TOOLS

Series 142



Item no.	Dimensions [mm]						
	a	b	c	d	e	f	x
31003957	10	16	135	19	35	30.3	2.4
31003958	12	16	135	19	35	30.3	2.4
31003959	16	16	135	19	35	30.3	2.4

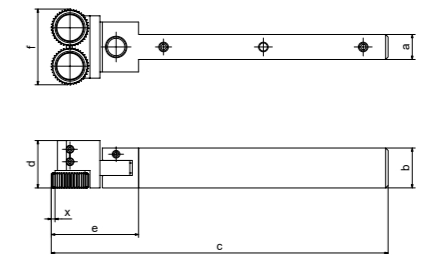

Item no.	Dimensions [mm]						
	a	b	c	d	e	f	x
31002801	10	10	110	19	30	30.4	1.5
31002803	12	12	110	19	30	30.4	1.5
31000751	16	16	118	19	39	33	1.5

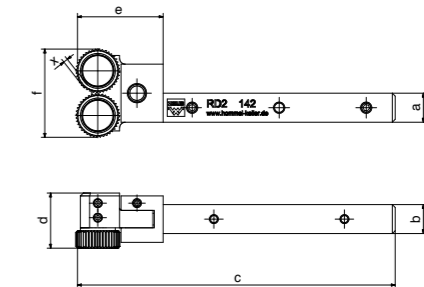

Item no.	Dimensions [mm]						
	a	b	c	d	e	f	x
31000752	20	20	130	24	50	42	1.2
31000753	25	20	130	24	50	46	1.2

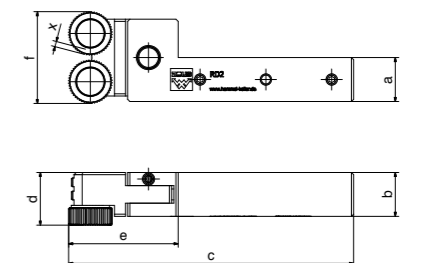

APPLICATION EXAMPLE

Series 142 | PROFILE UP TO SHOULDER



PROFILE RAA

PROFILE RGE



Series 142 | PROFILE UP TO A SHOULDER
KNURLING WHEELS: 2x AA | 1x BL, 1x BR



FORM KNURLING TOOLS

Ideal for very small workpiece diameters, features gentle tangential profiling

Series 161



Knurling profiles on workpiece (DIN 82):

Plunge / feed knurling



Selection of knurling wheels:

2x AA	2x BR	2x BL	1x BL / 1x BR
-------	-------	-------	---------------

Product features:

- Knurl holder is easily adjustable to workpiece diameter by means of synchronous spindle
- Set screws in shank for clearance angle correction
- Carbide pins with surface secured by set screw
- LD = Model for Swiss type lathes

TOOL VERSIONS / SPARE PARTS:

Available from stock

Item no. (right-hand version)	Item no. (left-hand version)	Model	Knurling wheel (Ø x w x b) [mm]	Workpiece Ø [mm]	Item no. Pin	Item no. Grub screw	Item no. Jaws
31013787 <input checked="" type="checkbox"/>		161-08-LD	10 x 4 x 4	0 – 12.5	06TER0964	06TER2155	21BHR9748
31013788 <input checked="" type="checkbox"/>		161-10-LD	10 x 4 x 4	0 – 12.5	06TER0964	06TER2155	21BHR9748
31013789 <input checked="" type="checkbox"/>		161-12-LD	10 x 4 x 4	0 – 12.5	06TER0964	06TER2155	21BHR9748
31013790 <input checked="" type="checkbox"/>		161-16-LD	10 x 4 x 4	0 – 12.5	06TER0964	06TER2155	21BHR9748
31002719 <input checked="" type="checkbox"/>	31002720 <input checked="" type="checkbox"/>	161-10	15 x 4 x 4	0 – 15	06TER0964	06TER2155	21BHR1672
31002722 <input checked="" type="checkbox"/>	31002723 <input checked="" type="checkbox"/>	161-12	15 x 4 x 4	0 – 15	06TER0964	06TER2155	21BHR1672
31002724 <input checked="" type="checkbox"/>	31002725 <input checked="" type="checkbox"/>	161-16	15 x 4 x 4	0 – 15	06TER0964	06TER2155	21BHR1672
31002127 <input checked="" type="checkbox"/>		161-20	20 x 8 x 6	3.5 – 65	21BHR1248	06TER2147	21BHR1213
			25 x 8 x 6	0 – 65	21BHR1248	06TER2147	21BHR1213
31002176 <input checked="" type="checkbox"/>		161-25	20 x 8 x 6	3.5 – 65	21BHR1248	06TER2147	21BHR1213
			25 x 8 x 6	0 – 65	21BHR1248	06TER2147	21BHR1213

ANWENDUNGSBEISPIEL

Series 161 | PROFILE RGE



PROFIL RGE30°



Serie 161 | OPTIMALE KRÄFTEVERTEILUNG - IDEAL FÜR LANGE UND DÜNNWANDIGE BAUTEILE

RÄNDELRÄDER: 1x BL30°, 1x BR30°



FORM KNURLING TOOLS

Series 161



Item no.	Dimensions [mm]							
	a	b	c	d	e	f	x	xa
31013787	8	16	107.4	19.6	27.4	30	1.3	5.4
31013788	10	16	107.4	19.6	27.4	30	1.3	5.4
31013789	12	16	107.4	19.6	27.4	30	1.3	5.4
31013790	16	16	107.4	19.6	27.4	30	1.3	5.4

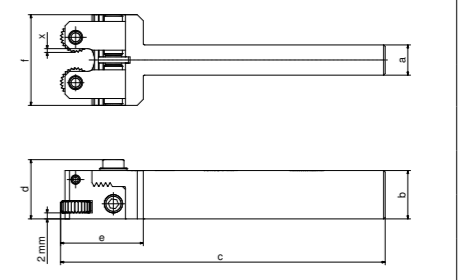

Item no. (right-hand version)	Item no. (left-hand version)	Dimensions [mm]							
		a	b	c	d	e	f	x	xa
31002719	31002720	10	10	113.4	19.6	33.4	40	2.5	8.9
31002722	31002723	12	12	113.4	19.6	33.4	40	2.5	8.9
31002724	31002725	16	16	113.4	19.6	33.4	40	2.5	8.9

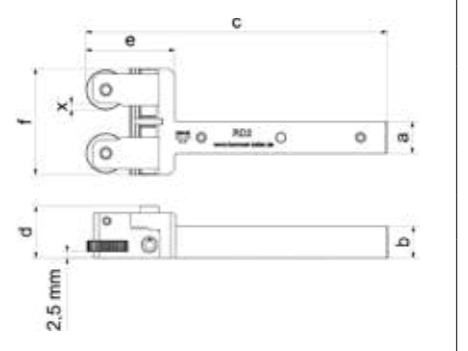

Item no.	Dimensions [mm]							
	a	b	c	d	e	f	x	xa
31002127	20	25	164.8	28.4	92.8	103	1.5	33.5
	20	25	167.3	28.4	95.3	103	4	33.5
31002176	25	25	167.3	28.4	92.8	103	1.5	33.5
	25	25	167.3	28.4	95.3	103	4	33.5

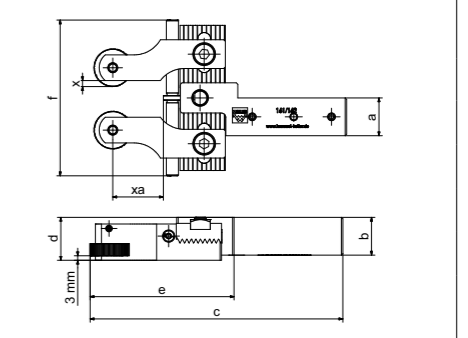



FORM KNURLING TOOLS

Ideal for very small workpiece diameters and applications up to a shoulder

Knurling profiles on workpiece (DIN 82):
Plunge / feed knurling



Selection of knurling wheels:

2x AA	2x BR	2x BL	1x BL / 1x BR
-------	-------	-------	---------------

Product features:

- Knurling wheels fixed by means of carbide bolt
- Knurl holder is easily adjustable to workpiece diameter by means of synchronous spindle
- Set screws in shank for clearance angle correction
- Modular shank design: Shank size 10 x 10 mm optionally adaptable
- LD = Model for Swiss type lathes

Series 162



TOOL VERSIONS / SPARE PARTS:

Item no. (right-hand version)	Item no. (left-hand version)	Model	Knurling wheel (Ø x w x b) [mm]	Workpiece Ø [mm]	Item no. Pin	Item no. Grub screw	Item no. Washer	Item no. Jaws
31002713 <input checked="" type="checkbox"/>	31002716 <input checked="" type="checkbox"/>	162-10	15 x 6 x 6A11	0 – 15	06TER0444	06TER2155	21BHR0375	21BHR1673
31002714 <input checked="" type="checkbox"/>	31002717 <input checked="" type="checkbox"/>	162-12	15 x 6 x 6A11	0 – 15	06TER0444	06TER2155	21BHR0375	21BHR1673
31002715 <input checked="" type="checkbox"/>	31002718 <input checked="" type="checkbox"/>	162-16	15 x 6 x 6A11	0 – 15	06TER0444	06TER2155	21BHR0375	21BHR1673
31002128 <input checked="" type="checkbox"/>		162-20	20 x 8 x 6A13	3.5 – 65	06TER0445	06TER2147	21BHR0380	21BHR1214
31002178 <input checked="" type="checkbox"/>		162-25	20 x 8 x 6A13	3.5 – 65	06TER0445	06TER2147	21BHR0380	21BHR1214

Available from stock



FORM KNURLING TOOLS

Series 162



Item no. (right-hand version)	Item no. (left-hand version)	Dimensions [mm]							
		a	b	c	d	e	f	x	x ₀
31002713	31002716	10	10	113.4	20.6	33.4	40	2.5	8.9
31002714	31002717	12	12	113.4	20.6	33.4	40	2.5	8.9
31002715	31002718	16	16	113.4	20.6	33.4	40	2.5	8.9

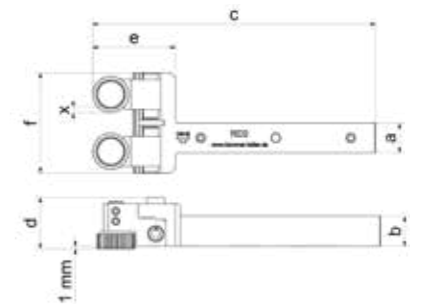

Item no.	Dimensions [mm]							
	a	b	c	d	e	f	x	x ₀
31002128	20	25	164.8	28.4	92.8	103	1.5	33.5
31002178	25	25	164.8	28.4	92.8	103	1.5	33.5

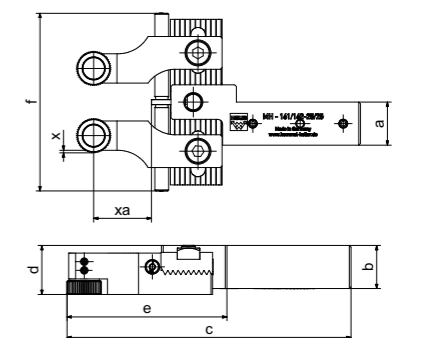



FORM KNURLING TOOLS - SETS

Maximum flexibility in combination – the perfect standard equipment

Set 100-12

SET consisting of:



- 1x Tool: 131
- 3x Knurling wheel: 15 x 4 x 4 mm
- 3x Profile: AA
- Pitches: 0.5 / 0.6 / 0.8 mm



- 1x Tool: 141
- 12x Knurling wheel: 10 x 4 x 4 mm
- 6x Profile: AA
- 3x Profile: BL30°
- 3x Profile: BR30°
- Pitches 0.5 / 0.6 / 0.8 mm

Knurling profiles on workpiece (DIN 82) for tool 131:
Plunge / feed knurling



Selection of knurling wheels:



Knurling profiles on workpiece (DIN 82): für Werkzeug 141:
Plunge / feed knurling



Selection of knurling wheels:

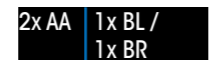

TOOL VERSIONS:

Available from stock

Item no. Set	Item no. Holder	Model	Knurling wheel (Ø x w x b) [mm]	Workpiece Ø [mm]	Dimensions [mm]
31002691 <input checked="" type="checkbox"/>	31002707	131-12	10 / 15 x 4 x 4	3 – 50	see page 8
	31002703	141-12	10 x 4 x 4	3 – 25	see page 10

Set 100-16

SET consisting of:



- 1x Tool: 131
- 3x Knurling wheel: 15 x 4 x 4 mm
- 3x Profile: AA
- Pitches: 0.6 / 0.8 / 1.0 mm



- 1x Tool: 141
- 12x Knurling wheel: 10 x 4 x 4 mm
- 6x Profile: AA
- 3x Profile: BL30°
- 3x Profile: BR30°
- Pitches: 0.6 / 0.8 / 1.0 mm

Knurling profiles on workpiece (DIN 82) for tool 131:
Plunge / feed knurling



Selection of knurling wheels:



Knurling profiles on workpiece (DIN 82) for tool 141:
Plunge / feed knurling



Selection of knurling wheels:

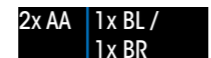

TOOL VERSIONS:

Available from stock

Item no. Set	Item no. Holder	Model	Knurling wheel (Ø x w x b) [mm]	Workpiece Ø [mm]	Dimensions [mm]
31002694 <input checked="" type="checkbox"/>	31002708	131-16	10 / 15 x 4 x 4	3 – 50	see page 8
	31002658	141-16	15 x 4 x 4	6 – 60	see page 10



FORM KNURLING TOOLS - SETS

Maximum flexibility in combination – the perfect standard equipment

Set 100-20

SET consisting of:



- 1x Tool: 131
- 3x Knurling wheel: 20 x 8 x 6 mm
- 3x Profile: AA
- Pitches: 0.8 / 1.0 / 1.5 mm



- 1x Tool: 141
- 12x Knurling wheel: 20 x 8 x 6 mm
- 6x Profile: AA
- 3x Profile: BL30°
- 3x Profile: BR30°
- Pitches: 0.8 / 1.0 / 1.5 mm

Knurling profiles on workpiece (DIN 82) for tool 131:
Plunge / feed knurling



Selection of knurling wheels:



Knurling profiles on workpiece (DIN 82) for tool 141:
Plunge / feed knurling



Selection of knurling wheels:



TOOL VERSIONS:

Available from stock

Item no. Set	Item no. Holder	Model	Knurling wheel (Ø x w x b) [mm]	Workpiece Ø [mm]	Dimensions [mm]
31002695 <input checked="" type="checkbox"/>	31000714	131-20	20 / 25 x 8 x 6	8 – 200	see page 8
	31002704	141-20	20 x 8 x 6	10 – 110	see page 10

Set 100-25

SET consisting of:



- 1x Tool: 131
- 3x Knurling wheel: 20 x 8 x 6 mm
- 3x Profile: AA
- Pitches: 0.8 / 1.0 / 1.5 mm



- 1x Tool: 141
- 12x Knurling wheel: 20 x 8 x 6 mm
- 6x Profile: AA
- 3x Profile: BL30°
- 3x Profile: BR30°
- Pitches: 0.8 / 1.0 / 1.5 mm

Knurling profiles on workpiece (DIN 82) for tool 131:
Plunge / feed knurling



Selection of knurling wheels:



Knurling profiles on workpiece (DIN 82) for tool 141:
Plunge / feed knurling



Selection of knurling wheels:

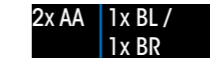

TOOL VERSIONS:

Available from stock

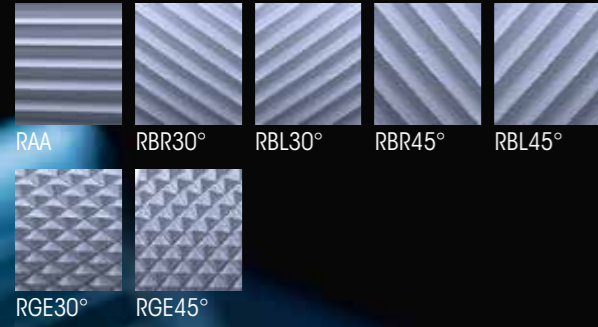

Item no. Set	Item no. Holder	Model	Knurling wheel (Ø x w x b) [mm]	Workpiece Ø [mm]	Dimensions [mm]
31002696 <input checked="" type="checkbox"/>	31000715	131-25	20 / 25 x 8 x 6	8 – 200	see page 8
	31002705	141-25	20 x 8 x 6	10 – 110	see page 10

Possible knurling profiles on the workpiece:



OVERVIEW OF CUT KNURLING TOOLS

With the product finder for cut knurling tools you can find your desired product faster. You receive all relevant tool data, as well as possible profiles, the corresponding knurling wheels and the possible direction of machining at a glance.

Tool series	Workpiece Ø [mm]	Profile on workpiece	Profile on knurling wheel	Shank [mm]	Knurling wheel Ø [mm]	Knurling	RAA	RBL	RBR	RGE
 231 (P. 22)	0 – 15 / 3 – 50	RAA RBR30° RBL30° RBR45° RBL45°	1x BR30° 1x AA 1x AA 1x BL15° 1x BR15°	10 / 12 / 16 20 / 25	10 / 15 25	Knurling starting at the workpiece beginning Knurling starting after plunge cut	●	●	●	–
	10 – 300						●	●	●	–
 241 (P. 23)	3 – 50	RGE30° RGE45°	2x AA 1x BR15° / 1x BL15°	10 / 12 / 16 / 20 16 / 20 / 25	15 25	Knurling starting at the workpiece beginning Knurling starting after plunge cut	–	–	–	●
	10 – 250						–	–	–	●

CUT KNURLING



Cut knurling is a machining process that uses cutting. The material is removed while being supplied at an axial feed rate. This process can therefore also be used for thin-walled or soft materials, as well as hard-to-machine materials.

ADDED VALUES

- maximum precision and surface quality, therefore especially suitable for visible knurling
- knurling of thin-walled workpieces is possible without deformation
- time savings due to faster cutting speed and feed rate
- machining of virtually all materials, including grey cast iron and plastic
- minimal material displacement
- minimal surface compaction

FORM KNURLING AND

CUT KNURLING TOOLS WITH INTERCHANGEABLE JAWS

Tool series	Workpiece Ø [mm]	Profile on workpiece	Profile on knurling wheel	Shank Ø [mm]	Knurling wheel Ø [mm]	Knurling	RAA	RBL	RBR	RGE
 191 (P. 27)	2 – 13.5	RAA RBR30° RBL30° RBR45° RBL45° RGE30° RGE45°	3x AA 3x BL30° 3x BR30° 3x BL45° 3x BR45° 1x BL30° + 2x BR30° or 2x BL30° + 1x BR30° 1x BL45° + 2x BR45° or 2x BL45° + 1x BR45°	Ø 12	10 15	starting at the workpiece Knurling beginning	●	●	●	●
	3 – 8.5						●	●	●	●
 192 (P. 27)	3 – 12	RAA RBR30° RBL30° RBR45° RBL45° RGE30° RGE45°	3x AA 3x BL30° 3x BR30° 3x BL45° 3x BR45° 1x BL30° + 2x BR30° or 2x BL30° + 1x BR30° 1x BL45° + 2x BR45° or 2x BL45° + 1x BR45°	Ø 12	15	Knurling starting at the workpiece beginning	●	●	●	●
							●	●	●	●
 291 (P. 26)	3.5 – 13.5	RAA RGE30° RGE45°	1x BR30° + 2x BL30° 3x AA 2x BR15° + 1x BL15°	Ø 12	10	Knurling starting at the workpiece beginning	●	–	–	●
							●	–	–	●



CUT KNURLING TOOLS

Series 231



Perfect efficiency due to modular design, convincing process reliability due to sturdy construction

Knurling profiles on workpiece (DIN 82):

Feed knurling



Selection of knurling wheels:

1x BR30° (right-hand use)	1x AA (left-hand use) /	1x AA (right-hand use) /
1x BL30° (left-hand use)	1x BR15° (left-hand use)	1x BL15° (right-hand use)

Product features:

- Scaling and positioning aids
- Adjusting spindle for fine adjustment of the knurl profile
- Set screws in shank for clearance angle correction
- Coated carbide bearing bushes for improved antifrictional property
- LD = Model for Swiss type lathes

Available from stock

TOOL VERSIONS / SPARE PARTS:

Item no.	Model	Knurling wheel (Ø x w x b) [mm]	Workpiece Ø [mm]	Item no. E-Kit (Washer, Bushing, Screw)	Item no. Washer	Item no. Screw
31003826	231-08 - LD	10 x 3 x 6	0 – 15	21BHR9757	--	06TER0390
31003828	231-08- LD	15 x 4 x 8	3 – 50	21BHR9758	06TER0125	06TER0448
31003827	231-10- LD	10 x 3 x 6	0 – 15	21BHR9757	--	06TER0390
31003829	231-10- LD	15 x 4 x 8	3 – 50	21BHR9758	06TER0125	06TER0448
31003901	231-12- LD	10 x 3 x 6	0 – 15	21BHR9757	--	06TER0390
31003900	231-12- LD	15 x 4 x 8	3 – 50	21BHR9758	06TER0125	06TER0448
31003902	231-16- LD	10 x 3 x 6	0 – 15	21BHR9757	--	06TER0390
31003903	231-16- LD	15 x 4 x 8	3 – 50	21BHR9758	06TER0125	06TER0448
31002739	231-10	15 x 4 x 8	3 – 50	21BHR0792	06TER0125	06TER0443
31002740	231-12	15 x 4 x 8	3 – 50	21BHR0792	06TER0125	06TER0390
31002741	231-16	15 x 4 x 8	3 – 50	21BHR0792	06TER0125	06TER0390
31003650	231-16	25 x 6 x 8	10 – 300	21BHR0506	21BHR0016	06TER0864
31002652	231-20	25 x 6 x 8	10 – 300	21BHR0506	21BHR0016	06TER0864
31002445	231-25	25 x 6 x 8	10 – 300	21BHR0506	21BHR0016	06TER0864

Item no.	Dimensions [mm]						
	a	b	c	d	e	f	x
31003826	8	16	120	33	20	17.5	0.5
31003828	8	16	124	33	24	17.5	1.5
31003827	10	16	120	33	20	17.5	0.5
31003829	10	16	124	33	24	17.5	1.5
31003901	12	16	120	33	20	17.5	0.5
31003900	12	16	124	33	24	17.5	1.5
31003902	16	16	120	33	20	17.5	0.5
31003903	16	16	124	33	24	17.5	1.5

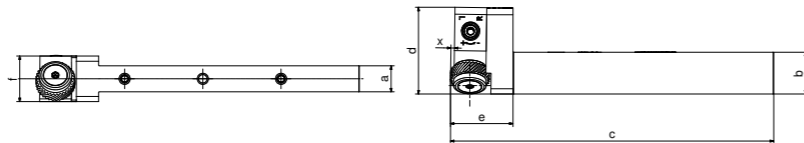

Item no.	Dimensions [mm]						
	a	b	c	d	e	f	x
31002739	10	10	104.1	36.2	24.1	25.3	1.2
31002740	12	12	104.1	36.2	24.1	25.3	1.2
31002741	16	16	104.1	36.2	24.1	29.3	1.2

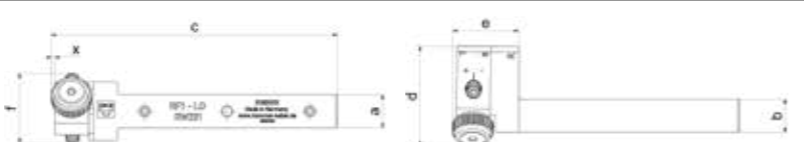

Item no.	Dimensions [mm]						
	a	b	c	d	e	f	x
31003650	16	16	130.8	35	50.4	36.3	3.8
31002652	20	20	130.4	35	50.4	36.3	3.7
31002445	25	25	130.8	35	50.8	40	3.7



CUT KNURLING TOOLS

Series 241



Excellent for stringent requirements – convincing stability in harsh continuous use

Knurling profiles on workpiece (DIN 82):

Feed knurling



Selection of knurling wheels:

2x AA	1x BL15° / 1x BR15°
-------	---------------------

Product features:

- Modular design: Tool can be used as right-hand and left-hand version. Retooling by simply turning the cut knurling head
- Conversion to alternative full shank dimensions is possible
- Modular shank design: Shank size 10 x 10 mm optionally adaptable
- Fine adjustment of centre height of the cut knurling head
- Fine adjustment of the clearance angle by means of synchronous adjustment spindle
- Coated carbide bearing bushes for improved antifrictional property Vertical height adjustment for use of shank size 20 mm on 25 mm (Item no. 31000666)

Available from stock

TOOL VERSIONS / SPARE PARTS:

Item no.	Model	Knurling wheel (Ø x w x b) [mm]	Workpiece Ø [mm]	Item no. E-Kit (Washer, Bushing, Screw)	Item no. Washer	Item no. Screw
31001926	241-10	15 x 4 x 8	3 – 50	21BHR0792	06TER0125	06TER0390
31001901	241-12	15 x 4 x 8	3 – 50	21BHR0792	06TER0125	06TER0390
31001945	241-16	15 x 4 x 8	3 – 50	21BHR0792	06TER0125	06TER0390
31000804	241-20	15 x 4 x 8	3 – 50	21BHR0792	06TER0125	06TER0390
31003651	241-16	25 x 6 x 8	10 – 250	21BHR0506	21BHR0016	06TER0864
31000666	241-20	25 x 6 x 8	10 – 250	21BHR0506	21BHR0016	06TER0864
31001899	241-25	25 x 6 x 8	10 – 250	21BHR0506	21BHR0016	06TER0864

Item no.	Dimensions [mm]					
	a	b	c	d	e	f
31001926	10	10	116	36.7	36	32.7
31001901	12	12	116	37.7	36	32.7
31001945	16	16	116	39.7	36	32.7
31000804	20	20	116	44.7	36	36.7

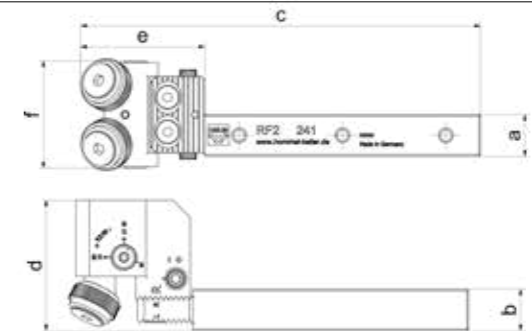

Item no.	Dimensions [mm]					
	a	b	c	d	e	f
31003651	16	20	133.3	68	53.3	53
31000666	20	20	133.3	67.7	53.3	53
31001899	25	20	133.3	67.8	53.3	52.9

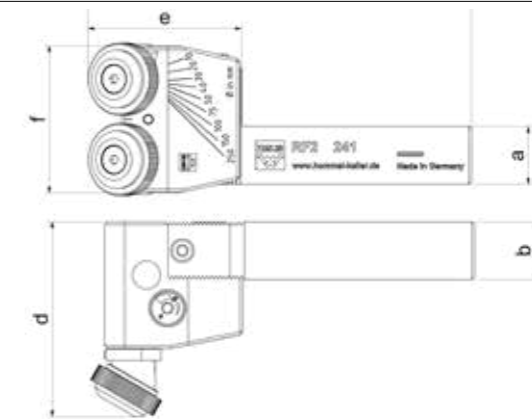



CUT KNURLING TOOLS - SETS

Maximum flexibility in combination – the perfect standard equipment

Set 200-12

SET consisting of:

- 1x Tool: 231
- 6x Knurling wheel: 15 x 4 x 8 mm
- 3x Profile: BL30°
- 3x Profile: BR30°
- Pitches: 0,5 / 0,6 / 0,8 mm



- 1x Tool: 241
- 6x Knurling wheel: 15 x 4 x 8 mm
- 6x Profile: AA
- Pitches: 0,5 / 0,6 / 0,8 mm

Knurling profiles on workpiece (DIN 82) for tool 231:

Feed knurling



Selection of knurling wheels:

1x BR30° (right-hand use)	1x AA (left-hand use)	1x AA (right-hand use)
1x BL30° (left-hand use)		

Knurling profiles on workpiece (DIN 82) for tool 241:

Feed knurling



Selection of knurling wheels:

2x AA

Available from stock

TOOL VERSIONS:

Item no. Set	Item no. Holder	Model	Knurling wheel (Ø x w x b) [mm]	Workpiece Ø [mm]	Dimensions [mm]
31002697 <input checked="" type="checkbox"/>	31002740	231-12	15 x 4 x 8	3 – 50	see page 18
	31001901	241-12	15 x 4 x 8	3 – 50	see page 19



CUT KNURLING TOOLS - SETS

Maximum flexibility in combination – the perfect standard equipment

Set 200-20

SET consisting of:

- 1x Tool: 231
- 6x Knurling wheel: 25 x 6 x 8 mm
- 3x Profile: BL30°
- 3x Profile: BR30°
- Pitches: 0,8 / 1,0 / 1,5 mm



- 1x Tool: 241
- 6x Knurling wheel: 25 x 6 x 8 mm
- 6x Profile: AA
- Pitches: 0,8 / 1,0 / 1,5 mm

Knurling profiles on workpiece (DIN 82) for tool 231:

Feed knurling



Selection of knurling wheels:

1x BR30° (right-hand use)	1x AA (left-hand use)	1x AA (right-hand use)
1x BL30° (left-hand use)		

Knurling profiles on workpiece (DIN 82) for tool 241:

Feed knurling

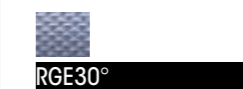

Selection of knurling wheels:

2x AA

Available from stock

TOOL VERSIONS:

Item no. Set	Item no. Holder	Model	Knurling wheel (Ø x w x b) [mm]	Workpiece Ø [mm]	Dimensions [mm]
31002699 <input checked="" type="checkbox"/>	31002652	231-20	25 x 6 x 8	10 – 300	see page 18
	31000666	241-20	25 x 6 x 8	10 – 250	see page 19

Set 200-16

SET consisting of:

- 1x Tool: 231
- 6x Knurling wheel: 15 x 4 x 8 mm
- 3x Profile: BL30°
- 3x Profile: BR30°
- Pitches: 0,6 / 0,8 / 1,0 mm



- 1x Tool: 241
- 6x Knurling wheel: 15 x 4 x 8 mm
- 6x Profile: AA
- Pitches: 0,6 / 0,8 / 1,0 mm

Knurling profiles on workpiece (DIN 82) for tool 231:

Feed knurling



Selection of knurling wheels:

1x BR30° (right-hand use)	1x AA (left-hand use)	1x AA (right-hand use)
1x BL30° (left-hand use)		

Knurling profiles on workpiece (DIN 82) for tool 241:

Feed knurling



Selection of knurling wheels:

2x AA

Available from stock

TOOL VERSIONS:

Item no. Set	Item no. Holder	Model	Knurling wheel (Ø x w x b) [mm]	Workpiece Ø [mm]	Dimensions [mm]
31002698 <input checked="" type="checkbox"/>	31002741	231-16	15 x 4 x 8	3 – 50	see page 18
	31001945	241-16	15 x 4 x 8	3 – 50	see page 19

Set 200-25

SET consisting of:

- 1x Tool: 231
- 6x Knurling wheel: 25 x 6 x 8 mm
- 3x Profile: BL30°
- 3x Profile: BR30°
- Pitches: 0,8 / 1,0 / 1,5 mm



- 1x Tool: 241
- 6x Knurling wheel: 25 x 6 x 8 mm
- 6x Profile: AA
- Pitches: 0,8 / 1,0 / 1,5 mm

Knurling profiles on workpiece (DIN 82) for tool 231:

Feed knurling



Selection of knurling wheels:

1x BR30° (right-hand use)	1x AA (left-hand use)	1x AA (right-hand use)
1x BL30° (left-hand use)		

Knurling profiles on workpiece (DIN 82) for tool 241:

Feed knurling



Selection of knurling wheels:

2x AA

Available from stock

TOOL VERSIONS:

Item no. Set	Item no. Holder	Model	Knurling wheel (Ø x w x b) [mm]	Workpiece Ø [mm]	Dimensions [mm]
31002700 <input checked="" type="checkbox"/>	31002445	231-25	25 x 6 x 8	10 – 300	see page 18
	31001899	241-25	25 x 6 x 8	10 – 250	see page 19



ONE TOOL FOR FORM KNURLING AND CUT KNURLING

KNURLING TOOLS WITH

KNURLING TOOL WITH CUT JAWS: 291



Knurling profiles on workpiece (DIN 82) with tool 291:

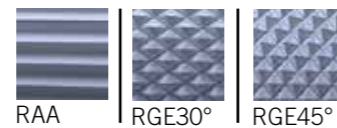

Selection of knurling wheels (DIN 403):

1x BR30° | 3x AA | 2x BR15°
2x BL30° | 1x BL15°

INTERCHANGEABLE JAWS

KNURLING TOOL WITH FORM JAWS: 191



KNURLING TOOL WITH FORM JAWS: 192



Knurling profiles on workpiece (DIN 82) with tools 191 and 192:

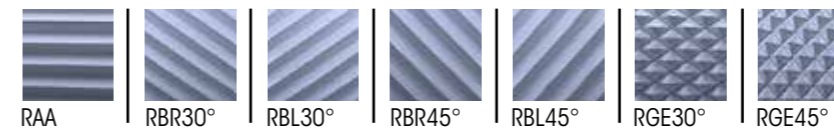

Selection of knurling wheels (DIN 403):

3x AA | 3x BL30° | 3x BR30° | 3x BL45° | 3x BR45° | 1x BR30° | 2x BL30° | 1x BR45° | 2x BL45°
2x BR30° | 1x BL30° | 2x BR45° | 1x BL45° or

Available from stock

PRODUCT FEATURES

- Knurl holders individually adjustable
- Maximum process stability
- All knurling processes can be used by exchanging the jaws
- Suitable for very small installation spaces due to compact design
- Force reduction through three-point machining
- Carbide pins / -bushing

PRODUCT FEATURES 192

- Knurling up to a shoulder

Item no.	Model	Workpiece Ø [mm]	Knurling wheel (Ø x w x b) [mm]	Item no. E-KIT (Washer, Bushing, Torx)	Item no. Pin	Item no. Grub screw	Item no. Interchangeable jaws
31001946 <input checked="" type="checkbox"/>	291-12	3.5-13.5	10 x 3 x 6	21BHR0791	-	-	21BHR1127
31001902 <input checked="" type="checkbox"/>	191-12	2-13.5	10 x 4 x 4	-	06TER0960	06TER2153	21BHR1096
		3-8.5	15 x 4 x 4	-	06TER0960	06TER2153	21BHR1096
31001948 <input checked="" type="checkbox"/>	192-12	3-12	15 x 6 x 6A8	21BHR0510	-	-	21BHR1128

DIMENSIONS

Item no.	Dimensions [mm]									
	a Ø	d max	e	h	i Ø	j Ø	k Ø	l	n max	x Ø
31001946	12	57	78	45	9	16	54	3	56	1
31001902	12	57	78	45	9	16	54	9	56	1.5
										4
31001948	12	57	78	45	9	16	54	2	56	2.5

d = with max. workpiece-Ø
n = max. length of workpiece (with Ø)

DIMENSIONS 291

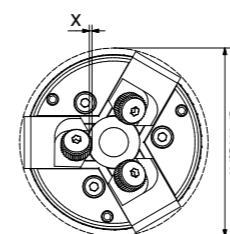
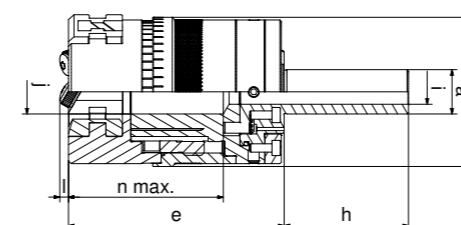

DIMENSIONS 191

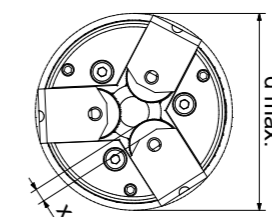
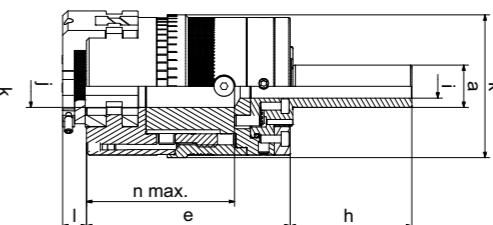

DIMENSIONS 192

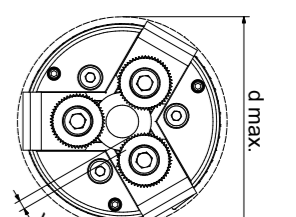
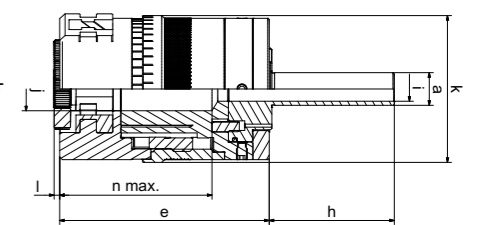



SPECIAL VARIANTS KNURLING TOOLS



SPECIAL VARIANTS KNURLING TOOLS

Specially designed for maximum stability and precision

Series 391



Ø 25 mm



Ø 30 mm

Knurling profiles on workpiece (DIN 82):

Feed knurling



RAA

RGE

Selection of knurling wheels (DIN 403):

3x AA	2x BL / 1x BR
	2x BR / 1x BL

Product features:

- No lateral contact pressures – minimum load on the workpiece
- Custom production – designed for workpiece diameter and pitch
- Dimensions correspond to standard for thread-cutting dies
- For use in standardised thread-cutting die holders

Available sizes:

- Ø 25 mm
- Ø 30 mm
- Ø 38 mm
- Ø 45 mm
- Ø 55 mm

- Base shanks are not included in scope of delivery, but are available on request

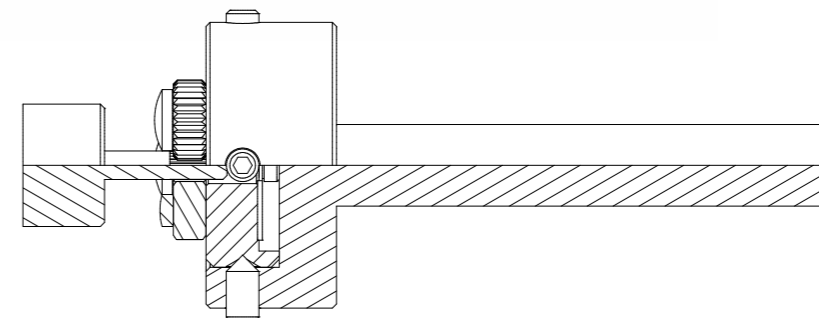

ALL REQUESTS FOR SPECIAL VARIANTS CAN ONLY BE PROCESSED WITH A WORKPIECE DRAWING.



SPECIAL VARIANTS KNURLING TOOLS

Series 311-xx°

Conical knurling
Face knurling

Conical/inner/face knurling
up to a shoulder



20° - 60°

90°

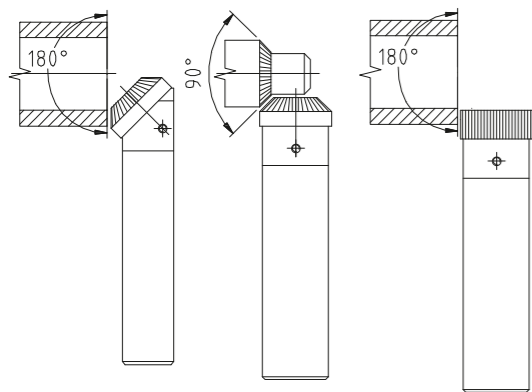

Knurling profiles on DIN 82 workpiece:

Plunge knurling



Selection of knurling wheels:



Series 312-xx°

Conical knurling



1° - 60°

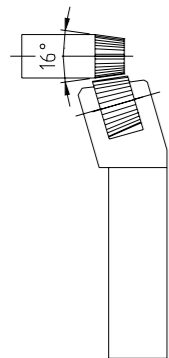

Knurling profiles on DIN 82 workpiece:

Plunge knurling



Selection of knurling wheels:



SPECIAL VARIANTS KNURLING TOOLS

Series 330

Knurling within a bore

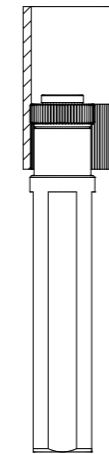

Knurling profiles on DIN 82 workpiece:

Plunge knurling



Selection of knurling wheels:



Feed knurling



Selection of knurling wheels:



Series 332

Knurling within a bore
up to a shoulder

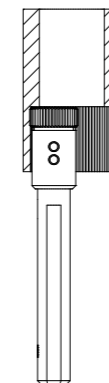

Knurling profiles on DIN 82 workpiece:

Plunge knurling



Selection of knurling wheels:



Feed knurling



Selection of knurling wheels:



Series 342

Knurling within a bore
up to a shoulder



Knurling profiles on DIN 82 workpiece:

Plunge knurling



Selection of knurling wheels:

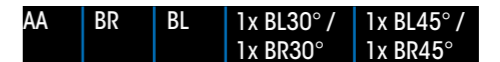

Feed knurling



Selection of knurling wheels:





SPECIAL VARIANTS KNURLING TOOLS

Series 161-S

Integrated turret holder
Expanded work area



Knurling profiles on DIN 82 workpiece:
Plunge knurling



Selection of knurling wheels:

2 x AA	1 x BL30°	1 x BL45°
	1 x BR30°	1 x BR45°

Product features:

- Flexible work area
- Extremely stable design
- Direct machine connection
- Conical application
- Carbide pins

Working area:

- Ø 0–15 mm



SPECIAL VARIANTS KNURLING TOOLS

Series 142-S

Special Capto® holder



Knurling profiles on DIN 82 workpiece:
Plunge/feed knurling



Selection of knurling wheels:

2 x AA	1 x BL30°	1 x BL45° /
	1 x BR30°	1 x BR45°

Product features:

- Knurling up to a shoulder
- Capto holder
- Knurling head with flexible centring
- Modularity – application independent
- Carbide pins

Working area:

- Ø 3 - 40 mm
- Ø 6 - 60 mm
- Ø 10 - 110 mm

Series 161-S

Conical knurling
Adjustable jaws 4–12°



Knurling profiles on DIN 82 workpiece:
Plunge/feed knurling



Selection of knurling wheels:

2x AA	2x BR	2x BL	1x BL30°	1x BL45° /
			1x BR30°	1x BR45°

Product features:

- Adjustable jaws 4–12°
- Star turret holder
- Flexible work area – conical surfaces
- Reduced strain on workpiece and machine
- Knurling head with flexible centring
- Modular shank design
- Carbide pin

Working area:

- Ø 8–36 mm

Series 192-S

Special HSK 32 holder



Knurling profiles on DIN 82 workpiece:
Feed knurling



Selection of knurling wheels:

2x AA	2x (1x) BL30° /	2x (1x) BL45° /
	1x (2x) BR30°	1x (2x) BR45°

Product features:

- Knurling up to a shoulder
- HSK holder
- No lateral contact pressure – reduced load
- Modular exchangeable knurl holder jaws
- Suitable for very small workpieces
- Exchangeable shank
- Easy and precise fine adjustment (synchronous)
- Carbide pins/bearing bolts

Working area:

- Ø 4–30 mm

Series 161-S

Knurling wheels in special size/form



Knurling profiles on DIN 82 workpiece:
Plunge/feed knurling



Selection of knurling wheels:

2x AA	2x (1x) BL30° /	2x (1x) BL45° /
	1x (2x) BR30°	1x (2x) BR45°

Product features:

- HSK holder
- No lateral contact pressure – reduced load
- Centre height adjustable due to synchronous spindle
- Carbide pins

Working area:

- Ø 0–20 mm

Form knurling/ marking

Special facing slide head holder



Knurling profiles on DIN 82 workpiece:
Plunge/feed knurling



Selection of knurling wheels:

1x AA	1x BR	1x BL
-------	-------	-------

Product features:

- Holder for facing slide head
- Special width for custom applications (knurling wheel/marketing roll)
- Carbide pins

Working area:

- Dependent on facing slide head



KNURLING WHEELS



FORM KNURLING WHEELS

non-cutting process



AA

zeus knurling wheels according to DIN 403 for profiles according to DIN 82, with chamfer 45°, PM

Profile AA

Item no.	Product group	Profile	Spiral angle	Ø (mm)	Width (mm)	Bore (mm)	Pitch (mm)
41014502	11	AA	0	10	4	4	0.3
41009690	11	AA	0	10	4	4	0.4
41008170	11	AA	0	10	4	4	0.5
41008452	11	AA	0	10	4	4	0.6
41010150	11	AA	0	10	4	4	0.7
41007356	11	AA	0	10	4	4	0.8
41010136	11	AA	0	10	4	4	1
41011071	11	AA	0	10	4	4	1.2
41015697	11	AA	0	10	4	4	1.5
41013392	11	AA	0	15	4	4	0.3
41012169	11	AA	0	15	4	4	0.4
41007191	11	AA	0	15	4	4	0.5
41007312	11	AA	0	15	4	4	0.6
41011113	11	AA	0	15	4	4	0.7
41007807	11	AA	0	15	4	4	0.8
41015073	11	AA	0	15	4	4	0.9
41007737	11	AA	0	15	4	4	1
41007748	11	AA	0	15	4	4	1.2
41007739	11	AA	0	15	4	4	1.5
41012009	11	AA	0	15	6	4	0.3
41015306	11	AA	0	15	6	4	0.4
41012066	11	AA	0	15	6	4	0.5
41011047	11	AA	0	15	6	4	0.6
41012783	11	AA	0	15	6	4	0.8
41015307	11	AA	0	15	6	4	0.9
41011375	11	AA	0	15	6	4	1
41014956	11	AA	0	15	6	4	1.2
41014958	11	AA	0	15	6	4	1.5
41015963	11	AA	0	15	6	6A8	0.6
41012084	11	AA	0	15	6	6A8	0.8
41015390	11	AA	0	15	6	6A8	1
41014708	11	AA	0	15	6	6A11	0.5
41011751	11	AA	0	15	6	6A11	0.6
41010869	11	AA	0	15	6	6A11	0.8
41010201	11	AA	0	15	6	6A11	1
41012902	11	AA	0	15	6	6A11	1.2
41015060	11	AA	0	20	6	6	0.4
41012734	11	AA	0	20	6	6	0.5
41012735	11	AA	0	20	6	6	0.6
41008306	11	AA	0	20	6	6	0.8
41007514	11	AA	0	20	6	6	1
41007802	11	AA	0	20	6	6	1.2
41007948	11	AA	0	20	6	6	1.5
41007041	11	AA	0	20	6	6	1.6

Item no.	Product group	Profile	Spiral angle	Ø (mm)	Width (mm)	Bore (mm)	Pitch (mm)
41015173	11	AA	0	20	8	6	0.3
41015174	11	AA	0	20	8	6	0.4
41007303	11	AA	0	20	8	6	0.5
41007304	11	AA	0	20	8	6	0.6
41010305	11	AA	0	20	8	6	0.7
41008208	11	AA	0	20	8	6	0.8
41015175	11	AA	0	20	8	6	0.9
41007357	11	AA	0	20	8	6	1
41008603	11	AA	0	20	8	6	1.2
41008354	11	AA	0	20	8	6	1.5
41012327	11	AA	0	20	8	6	1.6
41010418	11	AA	0	20	8	6	2
41013770	11	AA	0	20	8	6A13	0.5
41015455	11	AA	0	20	8	6A13	0.6
41011477	11	AA	0	20	8	6A13	0.8
41009204	11	AA	0	20	8	6A13	1
41012892	11	AA	0	20	8	6A13	1.2
41012893	11	AA	0	20	8	6A13	1.5
41007741	11	AA	0	20	10	6	0.5
41013841	11	AA	0	20	10	6	0.6
41008281	11	AA	0	20	10	6	0.8
41008672	11	AA	0	20	10	6	1
41011395	11	AA	0	20	10	6	1.2
41008564	11	AA	0	20	10	6	1.5
41015934	11	AA	0	25	6	6	0.6
41007361	11	AA	0	25	6	6	0.8
41008030	11	AA	0	25	6	6	1
41007716	11	AA	0	25	6	6	1.2
41016215	11	AA	0	25	6	6	1.5
41016224	11	AA	0	25	8	6	0.6
41010169	11	AA	0	25	8	6	0.8
41007421	11	AA	0	25	8	6	1
41007554	11	AA	0	25	8	6	1.2
41009373	11	AA	0	25	8	6	1.5



FORM KNURLING WHEELS

non-cutting process



BL30°



BL45°

zeus knurling wheels according to DIN 403 for profiles according to DIN 82, with chamfer 45°, PM

Profile BL

Item no.	Product group	Profile	Spiral angle	Ø (mm)	Width (mm)	Bore (mm)	Pitch (mm)
41015698	11	BL	30	10	4	4	0.3
41015699	11	BL	30	10	4	4	0.4
41010091	11	BL	30	10	4	4	0.5
41008997	11	BL	30	10	4	4	0.6
41008673	11	BL	30	10	4	4	0.7
41011077	11	BL	30	10	4	4	0.8
41010803	11	BL	30	10	4	4	1
41011078	11	BL	30	10	4	4	1.2
41015701	11	BL	30	10	4	4	1.5
41015702	11	BL	45	10	4	4	0.3
41015703	11	BL	45	10	4	4	0.4
41014711	11	BL	45	10	4	4	0.5
41013953	11	BL	45	10	4	4	0.6
41010089	11	BL	45	10	4	4	0.8
41013954	11	BL	45	10	4	4	1
41013000	11	BL	45	10	4	4	1.2
41011664	11	BL	30	15	4	4	0.5
41007033	11	BL	30	15	4	4	0.6
41011079	11	BL	30	15	4	4	0.8
41008148	11	BL	30	15	4	4	1
41011080	11	BL	30	15	4	4	1.2
41007691	11	BL	30	15	4	4	1.5
41015252	11	BL	45	15	4	4	0.5
41015253	11	BL	45	15	4	4	0.6
41015254	11	BL	45	15	4	4	0.8
41015256	11	BL	45	15	4	4	1
41008146	11	BL	45	15	4	4	1.2
41012730	11	BL	30	15	6	4	0.5
41010784	11	BL	30	15	6	4	0.6
41012731	11	BL	30	15	6	4	0.8
41015312	11	BL	30	15	6	4	1
41015313	11	BL	30	15	6	4	1.2
41015316	11	BL	45	15	6	4	0.4
41011684	11	BL	45	15	6	4	0.8
41013332	11	BL	45	15	6	4	1
41015320	11	BL	45	15	6	4	1.2
41016114	11	BL	30	15	6	6A8	0.6
41016115	11	BL	30	15	6	6A8	0.8
41016116	11	BL	30	15	6	6A8	1
41009186	11	BL	30	15	6	6A11	0.5
41016144	11	BL	30	15	6	6A11	0.8
41016145	11	BL	30	15	6	6A11	1
41014710	11	BL	45	15	6	6A11	0.5
41012904	11	BL	45	15	6	6A11	0.8
41012906	11	BL	45	15	6	6A11	1
41012910	11	BL	45	15	6	6A11	1.2



FORM KNURLING WHEELS

non-cutting process



BR30°



BR45°

zeus knurling wheels according to DIN 403 for profiles according to DIN 82, with chamfer 45°, PM

Profile BR

Item no.	Product group	Profile	Spiral angle	Ø (mm)	Width (mm)	Bore (mm)	Pitch (mm)
41015707	11	BR	30	10	4	4	0.3
41015708	11	BR	30	10	4	4	0.4
41010092	11	BR	30	10	4	4	0.5
41008998	11	BR	30	10	4	4	0.6
41008674	11	BR	30	10	4	4	0.7
41011072	11	BR	30	10	4	4	0.8
41010805	11	BR	30	10	4	4	1
41011073	11	BR	30	10	4	4	1.2
41015710	11	BR	30	10	4	4	1.5
41015711	11	BR	45	10	4	4	0.3
41015712	11	BR	45	10	4	4	0.4
41014712	11	BR	45	10	4	4	0.5
41013958	11	BR	45	10	4	4	0.6
41010090	11	BR	45	10	4	4	0.8
41013955	11	BR	45	10	4	4	1
41012999	11	BR	45	10	4	4	1.2
41011665	11	BR	30	15	4	4	0.5
41007032	11	BR	30	15	4	4	0.6
41011074	11	BR	30	15	4	4	0.8
41008147	11	BR	30	15	4	4	1
41011075	11	BR	30	15	4	4	1.2
41007690	11	BR	30	15	4	4	1.5
41015262	11	BR	45	15	4	4	0.5
41015263	11	BR	45	15	4	4	0.6
41008106	11	BR	45	15	4	4	0.8
41015265	11	BR	45	15	4	4	1
41008145	11	BR	45	15	4	4	1.2
41012732	11	BR	30	15	6	4	0.5
41010783	11	BR	30	15	6	4	0.6
41012733	11	BR	30	15	6	4	0.8
41013882	11	BR	30	15	6	4	1
41015425	11	BR	30	15	6	4	1.2
41015427	11	BR	45	15	6	4	0.4
41011683	11	BR	45	15	6	4	0.8
41013333	11	BR	45	15	6	4	1
41015431	11	BR	45	15	6	4	1.2
41016127	11	BR	30	15	6	6A8	0.6
41016128	11	BR	30	15	6	6A8	0.8
41016129	11	BR	30	15	6	6A8	1
41009187	11	BR	30	15	6	6A11	0.5
41016149	11	BR	30	15	6	6A11	0.8
41016150	11	BR	30	15	6	6A11	1
41014709	11	BR	45	15	6	6A11	0.5
41012905	11	BR	45	15	6	6A11	0.8
41012907	11	BR	45	15	6	6A11	1
41012908	11	BR	45	15	6	6A11	1.2



FORM KNURLING WHEELS

non-cutting process



GE30°



GE45°



GV30°



GV45°

zeus knurling wheels according to DIN 403 for profiles according to DIN 82, with chamfer 45°, PM

Profile GE

Item no.	Product group	Profile	Spiral angle	Ø (mm)	Width (mm)	Bore (mm)	Pitch (mm)
41015267	11	GE	30	15	4	4	0.5
41013348	11	GE	30	15	4	4	0.6
41014787	11	GE	30	15	4	4	0.8
41014788	11	GE	30	15	4	4	1
41014789	11	GE	30	15	4	4	1.2
41015786	11	GE	30	15	6	4	0.5
41014077	11	GE	30	15	6	4	0.6
41015857	11	GE	30	15	6	4	0.8
41014037	11	GE	30	15	6	4	1
41016100	11	GE	45	15	6	4	1
41014595	11	GE	30	20	6	6	0.8
41015155	11	GE	30	20	6	6	1
41015166	11	GE	45	20	6	6	0.8
41015217	11	GE	30	20	8	6	0.5
41013960	11	GE	30	20	8	6	0.6
41013060	11	GE	30	20	8	6	0.8
41007788	11	GE	30	20	8	6	1
41013061	11	GE	30	20	8	6	1.2
41013062	11	GE	30	20	8	6	1.5
41015223	11	GE	30	20	8	6	2
41015224	11	GE	45	20	8	6	0.3
41015196	11	GE	45	20	8	6	0.5
41012085	11	GE	45	20	8	6	0.8
41008500	11	GE	45	20	8	6	1
41008675	11	GE	45	20	8	6	1.2
41014950	11	GE	45	20	8	6	1.5

Profile GV

Item no.	Product group	Profile	Spiral angle	Ø (mm)	Width (mm)	Bore (mm)	Pitch (mm)
41020546	21	GV	45	10	4	4	0.3
41016943	21	GV	45	10	4	4	0.4
41020547	21	GV	45	10	4	4	0.5
41015461	21	GV	45	10	4	4	0.6
41007192	21	GV	30	15	4	4	0.5
41011393	21	GV	30	15	4	4	0.6
41014087	21	GV	30	15	4	4	0.8
41013229	21	GV	30	15	4	4	1
41015621	21	GV	30	15	4	4	1.2
41015625	21	GV	45	15	4	4	0.5
41011846	21	GV	45	15	4	4	0.6
41015629	21	GV	45	15	4	4	1
41015630	21	GV	45	15	4	4	1.2
41023634	21	GV	30	15	6	4	0.5
41015446	21	GV	30	15	6	4	0.6
41014830	21	GV	30	15	6	4	0.8
41013787	21	GV	30	15	6	4	1
41015644	21	GV	30	15	6	4	1.2
41015197	21	GV	30	20	6	6	0.6
41015673	21	GV	30	20	6	6	0.8
41013622	21	GV	30	20	6	6	1
41015684	21	GV	30	20	8	6	0.5
41015685	21	GV	30	20	8	6	0.6
41014562	21	GV	30	20	8	6	0.8
41013436	21	GV	30	20	8	6	1
41015688	21	GV	30	20	8	6	1.2
41015689	21	GV	30	20	8	6	1.5
41015498	21	GV	45	20	8	6	0.5
41015383	21	GV	45	20	8	6	0.6
41013170	21	GV	45	20	8	6	0.8
41010183	21	GV	45	20	8	6	1
41015695	21	GV	45	20	8	6	1.2
41015351	21	GV	45	20	8	6	1.5
41016070	21	GV	30	25	8	6	0.8
41008338	21	GV	30	25	8	6	1



CUT KNURLING WHEELS

cutting process



AA

zeus knurling wheels according to DIN 403 for profiles according to DIN 82, without chamfer, PM

Profile AA

Item no.	Product group	Profile	Spiral angle	Ø (mm)	Width (mm)	Bore (mm)	Pitch (mm)
41015794	16	AA	0	8.9	2,5	4	0.3
41013748	16	AA	0	8.9	2,5	4	0.5
41008427	16	AA	0	8.9	2,5	4	0.6
41010772	16	AA	0	8.9	2,5	4	0.7
41012043	16	AA	0	8.9	2,5	4	0.8
41015136	16	AA	0	8.9	2,5	4	1
41010879	16	AA	0	10	3	6	0.5
41010724	16	AA	0	10	3	6	0.6
41010727	16	AA	0	10	3	6	0.8
41009767	16	AA	0	10	3	6	1
41015135	16	AA	0	10	3	6	1.2
41015860	16	AA	0	14.5	3	5	0.5
41010740	16	AA	0	14.5	3	5	0.6
41015864	16	AA	0	14.5	3	5	0.7
41009300	16	AA	0	14.5	3	5	0.8
41008428	16	AA	0	14.5	3	5	1
41010741	16	AA	0	14.5	3	5	1.2
41008406	16	AA	0	15	4	8	0.5
41008407	16	AA	0	15	4	8	0.6
41008408	16	AA	0	15	4	8	0.7
41007464	16	AA	0	15	4	8	0.8
41008409	16	AA	0	15	4	8	1
41007053	16	AA	0	15	4	8	1.2
41010443	16	AA	0	15	4	8	1.5
41008554	16	AA	0	21.5	5	8	0.6
41010502	16	AA	0	21.5	5	8	0.8
41010503	16	AA	0	21.5	5	8	1
41010743	16	AA	0	21.5	5	8	1.2
41008595	16	AA	0	21.5	5	8	1.5
41011886	16	AA	0	21.5	5	8	2
41001104	16	AA	0	25	6	8	0.5
41001105	16	AA	0	25	6	8	0.6
41001107	16	AA	0	25	6	8	0.8
41001109	16	AA	0	25	6	8	1
41001110	16	AA	0	25	6	8	1.2
41001111	16	AA	0	25	6	8	1.5
41001112	16	AA	0	25	6	8	1.6
41001114	16	AA	0	25	6	8	2



CUT KNURLING WHEELS

cutting process



BL15°

BL30°

zeus knurling wheels according to DIN 403 for profiles according to DIN 82, without chamfer, PM

Profile BL

Item no.	Product group	Profile	Spiral angle	Ø (mm)	Width (mm)	Bore (mm)	Pitch (mm)
41015785	16	BL	30	8,9	2,5	4	0.8
41015809	16	BL	30	8,9	2,5	4	1
41011615	16	BL	15	10	3	6	0.5
41010733	16	BL	15	10	3	6	0.6
41010409	16	BL	15	10	3	6	0.8
41008687	16	BL	15	10	3	6	1
41015835	16	BL	30	10	3	6	0.5
41010728	16	BL	30	10	3	6	0.6
41015836	16	BL	30	10	3	6	0.7
41010466	16	BL	30	10	3	6	0.8
41010729	16	BL	30	10	3	6	1
41015838	16	BL	30	10	3	6	1.2
41015868	16	BL	15	14,5	3	5	0.5
41010752	16	BL	15	14,5	3	5	0.6
41015869	16	BL	15	14,5	3	5	0.7
41010753	16	BL	15	14,5	3	5	0.8
41018680	16	BL	15	14,5	3	5	1
41000754	16	BL	15	14,5	3	5	1.2
41010671	16	BL	30	14,5	3	5	0.5
41010132	16	BL	30	14,5	3	5	0.6
41010405	16	BL	30	14,5	3	5	0.8
41009779	16	BL	30	14,5	3	5	1
41010193	16	BL	30	14,5	3	5	1.2
41011754	16	BL	15	15	4	8	0.5
41009251	16	BL	15	15	4	8	0.6
41007333	16	BL	15	15	4	8	0.8
41007382	16	BL	15	15	4	8	1
41007639	16	BL	15	15	4	8	1.2
41008013	16	BL	15	15	4	8	1.5
41015894	16	BL	30	15	4	8	0.3
41015895	16	BL	30	15	4	8	0.4
41010764	16	BL	30	15	4	8	0.5
41008587	16	BL	30	15	4	8	0.6
41010445	16	BL	30	15	4	8	0.7
41007857	16	BL	30	15	4	8	0.8
41015896	16	BL	30	15	4	8	0.9
41007043	16	BL	30	15	4	8	1
41010517	16	BL	30	15	4	8	1.2
41010730	16	BL	30	15	4	8	1.5

Item no.	Product group	Profile	Spiral angle	Ø (mm)	Width (mm)	Bore (mm)	Pitch (mm)
41009960	16	BL	15	21,5	5	8	0.8
41008513	16	BL	15	21,5	5	8	1
41010758	16	BL	15	21,5	5	8	1.2
41009132	16	BL	15	21,5	5	8	1.5
41009561	16	BL	30	21,5	5	8	0.8
41008591	16	BL	30	21,5	5	8	1
41010332	16	BL	15	25	6	8	0.5
41010495	16	BL	15	25	6	8	0.6
41009607	16	BL	15	25	6	8	0.8
41007044	16	BL	15	25	6	8	1
41006373	16	BL	15	25	6	8	1.2
41007299	16	BL	15	25	6	8	1.5
41008502	16	BL	15	25	6	8	1.6
41007300	16	BL	15	25	6	8	2
41012128	16	BL	30	25	6	8	0.5
41009147	16	BL	30	25	6	8	0.6
41008501	16	BL	30	25	6	8	0.8
41007031	16	BL	30	25	6	8	1
41007209	16	BL	30	25	6	8	1.2
41007424	16	BL	30	25	6	8	1.5
41010807	16	BL	30	25	6	8	1.6
41010620	16	BL	30	25	6	8	2



CUT KNURLING WHEELS

cutting process



BR15°

BR30°

zeus knurling wheels according to DIN 403 for profiles according to DIN 82, without chamfer, PM

Profile BR

Item no.	Product group	Profile	Spiral angle	Ø (mm)	Width (mm)	Bore (mm)	Pitch (mm)
41011952	16	BR	30	8,9	2,5	4	0.8
41015823	16	BR	30	8,9	2,5	4	1
41011616	16	BR	15	10	3	6	0.5
41010734	16	BR	15	10	3	6	0.6
41010408	16	BR	15	10	3	6	0.8
41008688	16	BR	15	10	3	6	1
41012951	16	BR	30	10	3	6	0.5
41010731	16	BR	30	10	3	6	0.6
41015844	16	BR	30	10	3	6	0.7
41009757	16	BR	30	10	3	6	0.8
41010732	16	BR	30	10	3	6	1
41015846	16	BR	30	10	3	6	1.2
41015877	16	BR	15	14,5	3	5	0.5
41010736	16	BR	15	14,5	3	5	0.6
41015878	16	BR	15	14,5	3	5	0.7
41010737	16	BR	15	14,5	3	5	0.8
41008682	16	BR	15	14,5	3	5	1
41010738	16	BR	15	14,5	3	5	1.2
41015882	16	BR	30	14,5	3	5	0.5
41010133	16	BR	30	14,5	3	5	0.6
41010750	16	BR	30	14,5	3	5	0.8
41010751	16	BR	30	14,5	3	5	1
41010299	16	BR	30	14,5	3	5	1.2
41011753	16	BR	15	15	4	8	0.5
41009252	16	BR	15	15	4	8	0.6
41007332	16	BR	15	15	4	8	0.8
41007381	16	BR	15	15	4	8	1
41010735	16	BR	15	15	4	8	1.2
41007423	16	BR	15	15	4	8	1.5
41009516	16	BR	30	15	4	8	0.3
41015899	16	BR	30	15	4	8	0.4
41007309	16	BR	30	15	4	8	0.5
41008402	16	BR	30	15	4	8	0.6
41010446	16	BR	30	15	4	8	0.7
41007045	16	BR	30	15	4	8	0.8
41013942	16	BR	30	15	4	8	0.9
41007046	16	BR	30	15	4	8	1
41008403	16	BR	30	15	4	8	1.2
41007230	16	BR	30	15	4	8	1.5

Item no.	Product group	Profile	Spiral angle	Ø (mm)	Width (mm)	Bore (mm)	Pitch (mm)
41010172	16	BR	15	21,5	5	8	0.8
41008514	16	BR	15	21,5	5	8	1
41010173	16	BR	15	21,5	5	8	1.2
41009133	16	BR	15	21,5	5	8	1.5
41010746	16	BR	30	21,5	5	8	0.8
41008592	16	BR	30	21,5	5	8	1
41011088	16	BR	15	25	6	8	0.5
41010496	16	BR	15	25	6	8	0.6
41009624	16	BR	15	25	6	8	0.8
41007047	16	BR	15	25	6	8	1
41006374	16	BR	15	25	6	8	1.2
41006375	16	BR	15	25	6	8	1.5
41008518	16	BR	15	25	6	8	1.6
41007301	16	BR	15	25	6	8	2
41009788	16	BR	30	25	6	8	0.5
41008637	16	BR	30	25	6	8	0.6
41007752	16	BR	30	25	6	8	0.8
41007465	16	BR	30	25	6	8	1
41008240	16	BR	30	25	6	8	1.2
41007197	16	BR	30	25	6	8	1.5
41014036	16	BR	30	25	6	8	1.6
41007369	16	BR	30	25	6	8	2



SPECIAL KNURLING WHEELS

Bead knurl – Nr. 60

Note: Please indicate the bead diameter when ordering.



HV

Conical knurling wheels – Nr. 70

Note: The completeness of the teeth on the workpiece is always dependent on the width / pitch of the knurling wheel.



KAA



KGE



KBR



KBL

Concave and convex knurling wheels – Nr. 80

* Only radiuses > 3 mm are possible.



C*



DL 20°*



DR 20°*

In the DL, DR, FL and FR versions the spiral angle must not exceed 20°.



E



FL 20°



FR 20°

Special knurling wheels – Nr. 90 / 92 / 93



Nr. 90



Nr. 92



Nr. 93

Note: The picture of knurling wheel no. 90 is provided as an example. It represents all special forms not covered by no. 92 (single stepped) and no. 93 (double stepped).

RADGEOMETRIEN

Designation	Abbreviation
Outer diameter	D1
Bore diameter	D2
Width	B1
Pitch	p
Stepped diameter	D3
Stepped diameter	D4
Collar stud bore diameter	D5
Radius	R
Total angle	GW

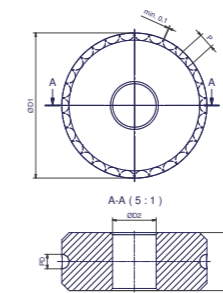

Bead knurl – Nr. 60

Designation	Abbreviation
Smallest diameter	Da
Average diameter	Dm
Bore depth	T1
Step width	B2
Step width	B3
Knurl width	RB
Knurl width + chamfer	RBF
Pearl diameter	PD

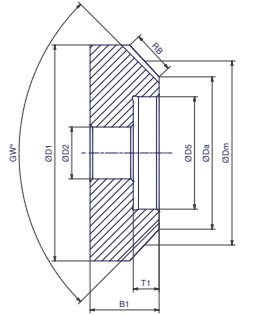

Conical knurling wheels – Nr. 70

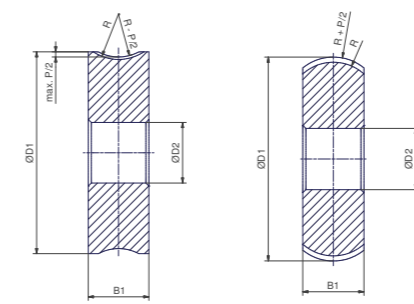

Concave / convex knurling wheels – Nr. 80

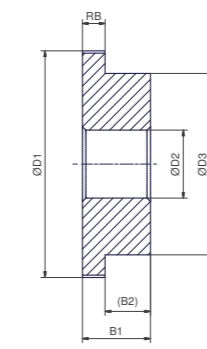

One-sided stepped knurling wheels – Nr. 92

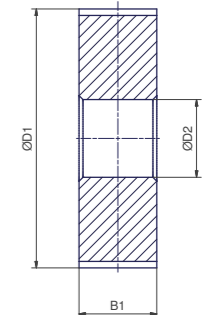

Special knurling wheels – Nr. 90

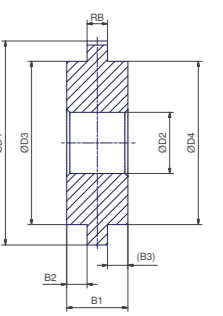

Double-sided stepped knurling wheels – Nr. 93

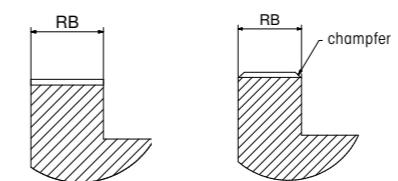

Knurl width and chamfer

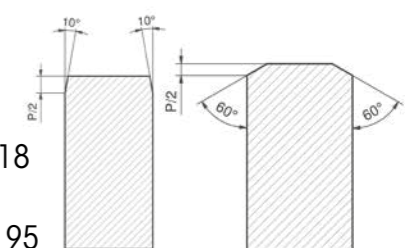

With 10° chamfer – Nr. 18

With 60° chamfer – Nr. 95



zeus Marking Technology

- marking workpieces in seconds
- on a wide variety of geometries independent of the workpiece diameter
- changing marking text thanks to interchangeable marking segments
- for machines with small installation space
- marking up to a shoulder

APPLICATIONS

Where and how can workpieces be marked?

The example shows that you can mark at practically any position. Whether you require marking on spherical or conical surface, up to a shoulder, on end face or inner surface – zeus marking tools will satisfy your requirements.

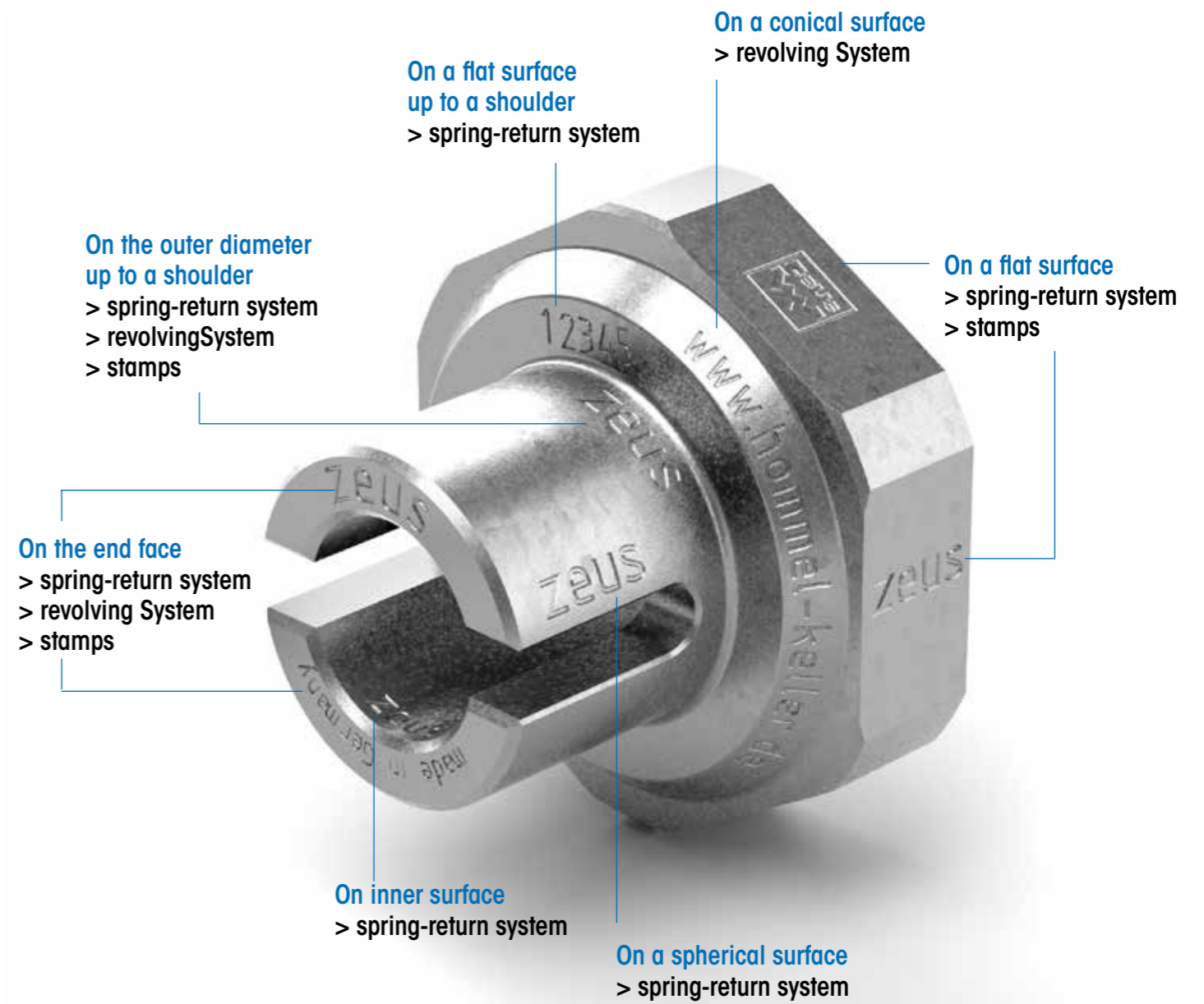

In marking technology there are two different processes: **spring-return** and the **revolving system**.

Both processes have their special applications and areas of utilisation.

Application Examples marking tools:

432:
Very flexible tool for different workpiece geometries and changing marking text

MARKING SEGMENTS IMMEDIATELY AVAILABLE:
A-Z, 0-9, -/.



422:
Extremely compact design ideal for Swiss type lathes









131 / 311:
Extremely cost efficient for consistent geometry and marking text









OVERWIEV

MARKING TOOLS

Spring-return system

Marking tool	Marking segment / Marking roll	Shank [mm] (adaptable to shank size)	Marking on workpiece, on different geometries	Marking up to a shoulder	Changing marking text possible	Center height integrated
 432 (P. 48)	 Marking segment No. 43	8 (10 / 12 / 16) 16 (20 / 25)	> on a flat surface > on a spherical surface > on the end face > on the outer diameter	✓	✓	✓
 431 (P. 50)	 Marking segment No. 42	16 (20 / 25)	> on a flat surface > on a spherical surface > on the end face > on the outer diameter	✗	✓	✓
 422 (P. 52)	 Marking roll No. 41	8 (10 / 12 / 16)	> on a flat surface > on a spherical surface > on the end face > on the outer diameter	✓	✗	✓
 421 (P. 53)	 Marking roll No. 41	16 (20 / 25)	> on a flat surface > on a spherical surface > on the end face > on the outer diameter	✗	✗	✓

Revolving system

 131 (P. 54)	 Marking roll No. 41	10 / 12 / 16 20 / 25	> on a conical surface > on the end face > on the outer diameter	✗	✗	✓
 311 (P. 55)	 Marking roll No. 40-K	application-specific	> on a conical surface > on the end face	✗	✗	✓
 312 (P. 55)	 Marking roll No. 40-K	application-specific	> on a conical surface > on the end face	✗	✗	✓



MARKING TOOL SET 432

Spring-return system



PRODUCT FEATURES

- modular shank design
- top edge of shank = centre height
- set screws in shank for correcting alignment
- hardened pin
- exact positioning of the marking on the circumference of the workpiece
- marking up to a shoulder
- center height corresponds to the first marking point
- marking position individually adjustable
- sets in high quality packaging

Available from stock

Item no. (right-hand version)	Item no. (left-hand version)	Model / Sets (with shank adapter)	Item no. E-Kit		
			right	left	
31002833 <input checked="" type="checkbox"/> (Set small version for segments Ø 30)	31002915 <input checked="" type="checkbox"/> (Set small version for segments Ø 30)	432-08	21BHR1081	21BHR1082	
		with adapter 10 x 10 mm			
		with adapter 12 x 12 mm			
		with adapter 16 x 16 mm			
		inkl. start- u. end segment			
31002849 <input checked="" type="checkbox"/> (Set big version for segments Ø 50)	31002873 <input checked="" type="checkbox"/> (Set big version for segments Ø 50)	432-16	21BHR1111	21BHR1112	
		with adapter 20 x 20 mm			
		with adapter 25 x 25 mm			
		inkl. start- u. end segment			

Item no. (right-hand version)	Item no. (left-hand version)	Dimensions [mm]						
		a	b	c	d	e	f	x
31002833 <input checked="" type="checkbox"/> (small version)	31002915 <input checked="" type="checkbox"/> (small version)	8	8	112.5	31.5	32.5	30	1
		10	10	112.5	31.5	32.5	30	1
		12	12	112.5	31.5	32.5	30	1
		16	16	112.5	31.5	32.5	31	1
31002849 <input checked="" type="checkbox"/> (big version)	31002873 <input checked="" type="checkbox"/> (big version)	16	16	137.5	31.5	57.5	48	1
		20	20	137.5	31.5	57.5	48	1
		25	25	137.5	31.5	57.5	48	1

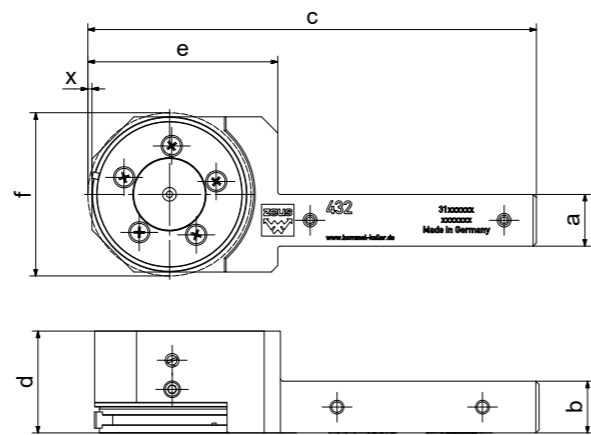

CHANGING MARKING TEXT



MARKING SEGMENTE Nr. 43 (for tool set 432)



SEGMENTS Ø 30 - small version
for Item no. 31002833 / 31002915

Standard design	
flank angle	90°
dimension (Ø x width x bore, mm)	30 x 8 x 18
font	according to DIN 1451



SEGMENTS Ø 50 - big version
for Item no. 31002849 / 31002873

Standard design	
flank angle	90°
dimension (Ø x width x bore, mm)	50 x 8 x 38
font	according to DIN 1451

Available from stock

Item no. character height 2 mm	Item no. character height 3 mm	Segments designations
85000000 <input checked="" type="checkbox"/>		Start segment
85001018 <input checked="" type="checkbox"/>	85001139 <input checked="" type="checkbox"/>	Letter set A-Z
85000992 <input checked="" type="checkbox"/>	85000346 <input checked="" type="checkbox"/>	A
85000993 <input checked="" type="checkbox"/>	85000356 <input checked="" type="checkbox"/>	B
85000994 <input checked="" type="checkbox"/>	85000344 <input checked="" type="checkbox"/>	C
85000995 <input checked="" type="checkbox"/>	85000347 <input checked="" type="checkbox"/>	D
85000996 <input checked="" type="checkbox"/>	85000348 <input checked="" type="checkbox"/>	E
85000997 <input checked="" type="checkbox"/>	85000349 <input checked="" type="checkbox"/>	F
85000998 <input checked="" type="checkbox"/>	85000350 <input checked="" type="checkbox"/>	G
85000999 <input checked="" type="checkbox"/>	85000351 <input checked="" type="checkbox"/>	H
85001000 <input checked="" type="checkbox"/>	85001407 <input checked="" type="checkbox"/>	I
85001001 <input checked="" type="checkbox"/>	85000352 <input checked="" type="checkbox"/>	J
85001002 <input checked="" type="checkbox"/>	85000353 <input checked="" type="checkbox"/>	K
85001003 <input checked="" type="checkbox"/>	85000354 <input checked="" type="checkbox"/>	L
85001004 <input checked="" type="checkbox"/>	85000355 <input checked="" type="checkbox"/>	M
85001005 <input checked="" type="checkbox"/>	85000852 <input checked="" type="checkbox"/>	N
85001006 <input checked="" type="checkbox"/>	85001408 <input checked="" type="checkbox"/>	O
85001007 <input checked="" type="checkbox"/>	85000855 <input checked="" type="checkbox"/>	P
85001008 <input checked="" type="checkbox"/>	85001409 <input checked="" type="checkbox"/>	Q
85001009 <input checked="" type="checkbox"/>	85001063 <input checked="" type="checkbox"/>	R
85001010 <input checked="" type="checkbox"/>	85000856 <input checked="" type="checkbox"/>	S
85001011 <input checked="" type="checkbox"/>	85001410 <input checked="" type="checkbox"/>	T
85001012 <input checked="" type="checkbox"/>	85001411 <input checked="" type="checkbox"/>	U
85001013 <input checked="" type="checkbox"/>	85001412 <input checked="" type="checkbox"/>	V
85001014 <input checked="" type="checkbox"/>	85000851 <input checked="" type="checkbox"/>	W
85001015 <input checked="" type="checkbox"/>	85001413 <input checked="" type="checkbox"/>	X
85001016 <input checked="" type="checkbox"/>	85001414 <input checked="" type="checkbox"/>	Y
85001017 <input checked="" type="checkbox"/>	85001415 <input checked="" type="checkbox"/>	Z
85000991 <input checked="" type="checkbox"/>	85000621 <input checked="" type="checkbox"/>	Numeral set 0-9
85000981 <input checked="" type="checkbox"/>	85000622 <input checked="" type="checkbox"/>	0
85000982 <input checked="" type="checkbox"/>	85000623 <input checked="" type="checkbox"/>	1
85000983 <input checked="" type="checkbox"/>	85000345 <input checked="" type="checkbox"/>	2
85000984 <input checked="" type="checkbox"/>	85000357 <input checked="" type="checkbox"/>	3
85000985 <input checked="" type="checkbox"/>	85000624 <input checked="" type="checkbox"/>	4
85000986 <input checked="" type="checkbox"/>	85000625 <input checked="" type="checkbox"/>	5
85000987 <input checked="" type="checkbox"/>	85000626 <input checked="" type="checkbox"/>	6
85000988 <input checked="" type="checkbox"/>	85000627 <input checked="" type="checkbox"/>	7
85000989 <input checked="" type="checkbox"/>	85000628 <input checked="" type="checkbox"/>	8
85000990 <input checked="" type="checkbox"/>	85000629 <input checked="" type="checkbox"/>	9
85002186 <input checked="" type="checkbox"/>		space segment
85001654 <input checked="" type="checkbox"/>	85001257 <input checked="" type="checkbox"/>	special character - (Minus)
85001019 <input checked="" type="checkbox"/>	85002485 <input checked="" type="checkbox"/>	special character . (Point)
85001059 <input checked="" type="checkbox"/>	85001537 <input checked="" type="checkbox"/>	special character / (Slash)
85000003 <input checked="" type="checkbox"/>		End segment

Item no. character height 2 mm	Item no. character height 3 mm	Segments designation
85000113 <input checked="" type="checkbox"/>		Start segment
85001819 <input checked="" type="checkbox"/>	85001283 <input checked="" type="checkbox"/>	Letter set A-Z
85001793 <input checked="" type="checkbox"/>	85001108 <input checked="" type="checkbox"/>	A
85001794 <input checked="" type="checkbox"/>	85001109 <input checked="" type="checkbox"/>	B
85001795 <input checked="" type="checkbox"/>	85001289 <input checked="" type="checkbox"/>	C
85001796 <input checked="" type="checkbox"/>	85001533 <input checked="" type="checkbox"/>	D
85001797 <input checked="" type="checkbox"/>	85001565 <input checked="" type="checkbox"/>	E
85001798 <input checked="" type="checkbox"/>	85001130 <input checked="" type="checkbox"/>	F
85001799 <input checked="" type="checkbox"/>	85001581 <input checked="" type="checkbox"/>	G
85001800 <input checked="" type="checkbox"/>	85001534 <input checked="" type="checkbox"/>	H
85001801 <input checked="" type="checkbox"/>	85001566 <input checked="" type="checkbox"/>	I
85001802 <input checked="" type="checkbox"/>	85001567 <input checked="" type="checkbox"/>	J
85001803 <input checked="" type="checkbox"/>	85001535 <input checked="" type="checkbox"/>	K
85001804 <input checked="" type="checkbox"/>	85001568 <input checked="" type="checkbox"/>	L
85001805 <input checked="" type="checkbox"/>	85001569 <input checked="" type="checkbox"/>	M
85001806 <input checked="" type="checkbox"/>	85001570 <input checked="" type="checkbox"/>	N
85001807 <input checked="" type="checkbox"/>	85001571 <input checked="" type="checkbox"/>	O
85001808 <input checked="" type="checkbox"/>	85001572 <input checked="" type="checkbox"/>	P
85001809 <input checked="" type="checkbox"/>	85001573 <input checked="" type="checkbox"/>	Q
85001810 <input checked="" type="checkbox"/>	85001574 <input checked="" type="checkbox"/>	R
85001811 <input checked="" type="checkbox"/>	85001575 <input checked="" type="checkbox"/>	S
85001812 <input checked="" type="checkbox"/>	85001576 <input checked="" type="checkbox"/>	T
85001813 <input checked="" type="checkbox"/>	85001290 <input checked="" type="checkbox"/>	U
85001814 <input checked="" type="checkbox"/>	85001577 <input checked="" type="checkbox"/>	V
85001815 <input checked="" type="checkbox"/>	85001578 <input checked="" type="checkbox"/>	W
85001816 <input checked="" type="checkbox"/>	85001579 <input checked="" type="checkbox"/>	X
85001817 <input checked="" type="checkbox"/>	85001580 <input checked="" type="checkbox"/>	Y
85001818 <input checked="" type="checkbox"/>	85001536 <input checked="" type="checkbox"/>	Z
85001431 <input checked="" type="checkbox"/>	85000476 <input checked="" type="checkbox"/>	Numeral set 0-9
85001421 <input checked="" type="checkbox"/>	85000466 <input checked="" type="checkbox"/>	0
85001422 <input checked="" type="checkbox"/>	85000467 <input checked="" type="checkbox"/>	1
85001423 <input checked="" type="checkbox"/>	85000468 <input checked="" type="checkbox"/>	2
85001424 <input checked="" type="checkbox"/>	85000469 <input checked="" type="checkbox"/>	3
85001425 <input checked="" type="checkbox"/>	85000470 <input checked="" type="checkbox"/>	4
85001426 <input checked="" type="checkbox"/>	85000471 <input checked="" type="checkbox"/>	5
85001427 <input checked="" type="checkbox"/>	85000472 <input checked="" type="checkbox"/>	6
85001428 <input checked="" type="checkbox"/>	85000473 <input checked="" type="checkbox"/>	7
85001429 <input checked="" type="checkbox"/>	85000474 <input checked="" type="checkbox"/>	8
85001430 <input checked="" type="checkbox"/>	85000475 <input checked="" type="checkbox"/>	9
85003870 <input checked="" type="checkbox"/>		space segment
85001912 <input checked="" type="checkbox"/>	85001600 <input checked="" type="checkbox"/>	special character - (Minus)
85002486 <input checked="" type="checkbox"/>	85002487 <input checked="" type="checkbox"/>	special character . (Point)
85001857 <input checked="" type="checkbox"/>	85001131 <input checked="" type="checkbox"/>	special character / (Slash)
85000114 <input checked="" type="checkbox"/>		End segment



MARKING TOOL SET 431

Spring-return system



PRODUCT FEATURES

- modular shank design
- top edge of shank = centre height
- set screws in shank for correcting alignment
- hardened pin
- exact positioning of the marking on the circumference of the workpiece
- center height corresponds to the first marking point
- marking position individually adjustable
- sets in high quality packaging

Available from stock

Item no.	Model / Sets (with shank adapter)	Item no. E-Kit		
		right	left	
31002845 <input checked="" type="checkbox"/>	431-16	21BHR1509	21BHR1510	
	with adapter 20 x 20 mm			
	with adapter 25 x 25 mm incl. start- and endsegment			

Item no.	Dimensions [mm]						
	a	b	c	d	e	f	x
31002845 <input checked="" type="checkbox"/>	16	16	130.5	30	50.5	45	2
	20	20	130.5	30	50.5	45	2
	25	25	130.5	30	50.5	47.5	2

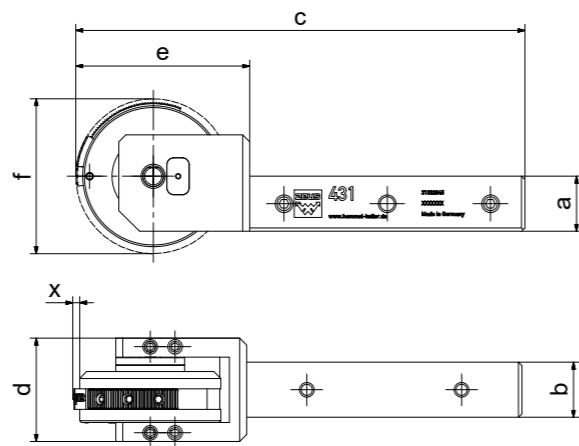

CHANGING MARKING TEXT



MARKING SEGMENTS Nr. 42 (for tool set 431)

SEGMENTS for Item no. 31002845



Standard design	
flank angle	90°
dimension (ø x width x bore, mm)	45 x 6 x 33
font	according to DIN 1451

Available from stock

Item no. character height 2 mm	Item no. character height 3 mm	Segments designations
82000067 <input checked="" type="checkbox"/>		Start segment
82002237 <input checked="" type="checkbox"/>		Letter set A-Z
82000438 <input checked="" type="checkbox"/>	82000028 <input checked="" type="checkbox"/>	A
82000439 <input checked="" type="checkbox"/>	82002232 <input checked="" type="checkbox"/>	B
82002236 <input checked="" type="checkbox"/>	82002301 <input checked="" type="checkbox"/>	C
82001063 <input checked="" type="checkbox"/>	82002302 <input checked="" type="checkbox"/>	D
82002240 <input checked="" type="checkbox"/>	82002303 <input checked="" type="checkbox"/>	E
82001064 <input checked="" type="checkbox"/>	82002304 <input checked="" type="checkbox"/>	F
82002242 <input checked="" type="checkbox"/>	82000430 <input checked="" type="checkbox"/>	G
82002243 <input checked="" type="checkbox"/>	82000431 <input checked="" type="checkbox"/>	H
82002244 <input checked="" type="checkbox"/>	82002045 <input checked="" type="checkbox"/>	I
82002245 <input checked="" type="checkbox"/>	82002308 <input checked="" type="checkbox"/>	J
82002246 <input checked="" type="checkbox"/>	82002309 <input checked="" type="checkbox"/>	K
82002247 <input checked="" type="checkbox"/>	82002310 <input checked="" type="checkbox"/>	L
82002248 <input checked="" type="checkbox"/>	82002311 <input checked="" type="checkbox"/>	M
82002249 <input checked="" type="checkbox"/>	82002312 <input checked="" type="checkbox"/>	N
82002250 <input checked="" type="checkbox"/>	82002313 <input checked="" type="checkbox"/>	O
82002251 <input checked="" type="checkbox"/>	82000429 <input checked="" type="checkbox"/>	P
82002252 <input checked="" type="checkbox"/>	82002315 <input checked="" type="checkbox"/>	Q
82001089 <input checked="" type="checkbox"/>	82002316 <input checked="" type="checkbox"/>	R
82002254 <input checked="" type="checkbox"/>	82000379 <input checked="" type="checkbox"/>	S
82002255 <input checked="" type="checkbox"/>	82002318 <input checked="" type="checkbox"/>	T
82002256 <input checked="" type="checkbox"/>	82002319 <input checked="" type="checkbox"/>	U
82002257 <input checked="" type="checkbox"/>	82002320 <input checked="" type="checkbox"/>	V
82000867 <input checked="" type="checkbox"/>	82002321 <input checked="" type="checkbox"/>	W
82002259 <input checked="" type="checkbox"/>	82002322 <input checked="" type="checkbox"/>	X
82002260 <input checked="" type="checkbox"/>	82002323 <input checked="" type="checkbox"/>	Y
82002261 <input checked="" type="checkbox"/>	82002324 <input checked="" type="checkbox"/>	Z

Item no. character height 2 mm	Item no. character height 3 mm	Segments designations
82000441 <input checked="" type="checkbox"/>	82000378 <input checked="" type="checkbox"/>	Numeral set 0-9
82000001 <input checked="" type="checkbox"/>	82000187 <input checked="" type="checkbox"/>	0
82000141 <input checked="" type="checkbox"/>	82000189 <input checked="" type="checkbox"/>	1
82000142 <input checked="" type="checkbox"/>	82000039 <input checked="" type="checkbox"/>	2
82000143 <input checked="" type="checkbox"/>	82000029 <input checked="" type="checkbox"/>	3
82000239 <input checked="" type="checkbox"/>	82000190 <input checked="" type="checkbox"/>	4
82000145 <input checked="" type="checkbox"/>	82000030 <input checked="" type="checkbox"/>	5
82000146 <input checked="" type="checkbox"/>	82000191 <input checked="" type="checkbox"/>	6
82000147 <input checked="" type="checkbox"/>	82000421 <input checked="" type="checkbox"/>	7
82000148 <input checked="" type="checkbox"/>	82000193 <input checked="" type="checkbox"/>	8
82000149 <input checked="" type="checkbox"/>	82000031 <input checked="" type="checkbox"/>	9
82000416 <input checked="" type="checkbox"/>	82000040 <input checked="" type="checkbox"/>	special character - (Minus)
82000433 <input checked="" type="checkbox"/>	82000041 <input checked="" type="checkbox"/>	special character . (Point)
82000879 <input checked="" type="checkbox"/>	82002230 <input checked="" type="checkbox"/>	special character / (Slash)
82000065 <input checked="" type="checkbox"/>		End segment



MARKING TOOL SET 422

Spring-return system



PRODUCT FEATURES

- modular shank design
- compact design - optimized for Swiss type lathe applications
- top edge of shank = centre height
- set screws in shank for correcting alignment
- hardened pin
- exact positioning of the marking on the circumference of the workpiece
- marking up to a shoulder
- center height corresponds to the first marking point
- marking position individually adjustable
- sets in high quality packaging

Available from stock

Item no. (right-hand version)	Item no. (left-hand version)	Model / Sets (with shank adapter)	Size Marking roll (Ø x w x b)	Item no. E-Kit		Image
				right	left	
31002843 <input checked="" type="checkbox"/> Tool for marking up to a shoulder	31002913 <input checked="" type="checkbox"/> Tool for marking up to a shoulder	422	15 x 5 x 6	21BHR1505	21BHR1506	
		with adapter 10 x 10 mm				
		with adapter 12 x 12 mm				
		with adapter 16 x 16 mm				
31002846 <input checked="" type="checkbox"/> Tool for marking up to a shoulder	31002914 <input checked="" type="checkbox"/> Tool for marking up to a shoulder	422	15 x 7 x 6	21BHR1507	21BHR1508	
		with adapter 10 x 10 mm				
		with adapter 12 x 12 mm				
		with adapter 16 x 16 mm				

Item no. (right-hand version)	Item no. (left-hand version)	Dimensions [mm]							Image
		a	b	c	d	e	f	x	
31002843 <input checked="" type="checkbox"/>	31002913 <input checked="" type="checkbox"/>	8	8	101	24	21	16	1	
		10	10	101	24	21	18	1	
		12	12	101	24	21	20	1	
		16	16	101	24	21	24	1	

Item no. (right-hand version)	Item no. (left-hand version)	Dimensions [mm]							Image
		a	b	c	d	e	f	x	
31002846 <input checked="" type="checkbox"/> Tool for marking up to a shoulder	31002914 <input checked="" type="checkbox"/> Tool for marking up to a shoulder	8	8	101	24.5	21	16	1	
		10	10	101	24.5	21	18	1	
		12	12	101	24.5	21	20	1	
		16	16	101	24.5	21	24	1	

MARKING ROLL Nr. 41

(for tool set 422)



Standard design	
flank angle	90°
dimension (Ø x width x bore, mm)	15 x 5 x 6 15 x 7 x 6
font	according to DIN 1451



MARKING TOOL SET 421

Spring-return system



PRODUCT FEATURES

- modular shank design
- top edge of shank = centre height
- set screws in shank for correcting alignment
- hardened pin
- exact positioning of the marking on the circumference of the workpiece
- Marking independent of workpiece diameter
- center height corresponds to the first marking point
- marking position individually adjustable
- sets in high quality packaging

Available from stock

Item no.	Model / Sets (with shank adapter)	Size Marking roll (Ø x w x b)	Item no. E-Kit		Image
			rechts	links	
31002844 <input checked="" type="checkbox"/>	421	25 x 6 x 6	21BHR1503	21BHR1504	
	with adapter 20 x 20 mm				
	with adapter 25 x 25 mm				

Item no.	Dimensions [mm]							Image
	a	b	c	d	e	f	x	
31002844 <input checked="" type="checkbox"/>	16	16	112.5	25	32.5	28.5	2.5	
	20	20	112.5	25	32.5	28.5	2.5	
	25	25	112.5	25	32.5	28.5	2.5	

MARKING ROLL Nr. 41

(for tool set 421)



Standard design	
flank angle	90°
dimension (Ø x width x bore, mm)	25 x 6 x 6
font	according to DIN 1451

APPLICATION EXAMPLE MARKING

MARK YOUR WORKPIECE IN SECONDS.



➔ INTEGRATED INTO THE MACHINING PROCESS



MARKING TOOL

Revolving system

TOOL No. 131

(catalogue page 8)

Perfect for recurring marking, impresses with its easy handling



TOOL No. 311 / 312

(catalogue page 30)

Perfect for marking on conical or flat surfaces



PRODUCT FEATURES

- easy handling
- very cost efficient and fast
- ideal for series production
- marking roll interchangeable
- marking roll is adjusted to the workpiece diameter
- top edge of shank = centre height (131 / 311 / 312)
- set screws in shank for correcting alignment

MARKING ROLL No. 40

(for tool no. 131)



MARKING ROLL No. 40-K

(for tool no. 311 / 312)



Standard design for
131 / 311 / 312

flank angle	90°
roll width [mm]	application-specific
font	according to DIN 1451

Application example

Tool No. 131 with marking roll Nr. 40

**EXTREMELY
COST EFFICIENT**

- For recurring marking on rotationally symmetrical components with constant diameter.

Application example

Tool No. 311 with marking roll Nr. 40-K

**PERFECT FOR
MARKING THE END FACE**

- When marking the end face, the calculated position of the pitch circle diameter must be observed.



zeus **Burnishing Technology**
zeus **Burnishing Rolls**



BURNISHING TOOLS

easy handling | reliable | surface quality up to $< R_z 1\mu\text{m}$



**Entry-level model
for Swiss type lathes**



**Easy handling
due to the new
spring spoke system**



**Reliable burnishing
process due to the new
stabilized guidance axis**



**Long tool life of the diamond
burnishing tip due to eightfold
change of tip position**



BURNISHING TOOL SET 510

The entry-level model for Swiss type lathes impresses with its easy handling.



BURNISHING TOOL SET 520

The flexible burnishing tool for almost all workpiece geometries.



Product features

- Fixed tool head
- New entry-level model for simple burnishing applications, e.g. for burnishing shafts with cylindrical surfaces
- Tool universally applicable
- Compact design - developed for Swiss type lathes
- Center height at middle of the shank
- Long tool life of the diamond burnishing tip due to eightfold change of tip position

Recommendations

- Burnishing speed up to 200 m/min
- Feed rate up to 0.2 mm/U
- Material allowance of 0.01 mm (~Rz 10) and 0.02 mm (~Rz 20)
- For an optimum result it is recommended to use a cooling lubricant

Product features

- Tool head is variably adjustable
- Tool universally applicable
- Swivel range $\pm 90^\circ$
- Thanks to the adjustability of the tool head, it is possible to burnish end face, conical, convex and concave geometries
- Application up to a shoulder
- Long tool life of the diamond burnishing tip due to eightfold change of tip position

Recommendations

- Burnishing speed up to 200 m/min
- Feed rate up to 0.2 mm/U
- Material allowance 0.01 mm (~Rz 10) and 0.02 mm (~Rz 20)
- For an optimum result it is recommended to use a cooling lubricant



TOOL VERSIONS:

Available from stock

Item no.	Tool holder model	Head angle	Basic shank [mm]	Dimensions [mm]								Including shank adapter [mm]
				a	b	c	d	e	f	x		
31003955	510-10	35°	10 x 10	10	10	113	22	28	15	9.5	12 x 12 16 x 16	
31003956	510-10	45°	10 x 10	10	10	104.6	24	24.6	15	9.5	12 x 12 16 x 16	

Sets delivered without diamond burnishing tip.

TOOL VERSIONS:

Available from stock

Item no. (right-hand version)	Item no. (left-hand version)	Tool holder model	Basic shank [mm]	Dimensions [mm]								Angle [°]		Including shank adapter [mm]
				a	b	c	d	e	f	g	x	+w	-w	
31003922	31013577	520-10	10 x 10	10	10	118.5	20	37.5	25	17.5	9.5	90	90	12 x 12 16 x 16
31003923		520-16	16 x 16	16	16	114.5	20	34.6	25	17.5	9.5	90	90	20 x 20 25 x 25

Sets delivered without diamond burnishing tip.

DIAMOND BURNISHING TIP VERSIONS:

Item no.	Tip radii [mm]
06TGW0024	0.2
06TGW0008	0.4
06TGW0009	0.6
06TGW0010	0.8
06TGW0011	1.0
06TGW0007	2.0

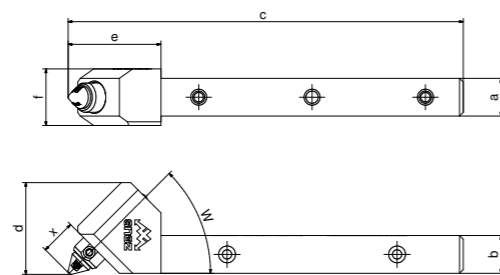

DIAMOND BURNISHING TIP VERSIONS:

Item no.	Tip radii [mm]
06TGW0024	0.2
06TGW0008	0.4
06TGW0009	0.6
06TGW0010	0.8
06TGW0011	1.0
06TGW0007	2.0

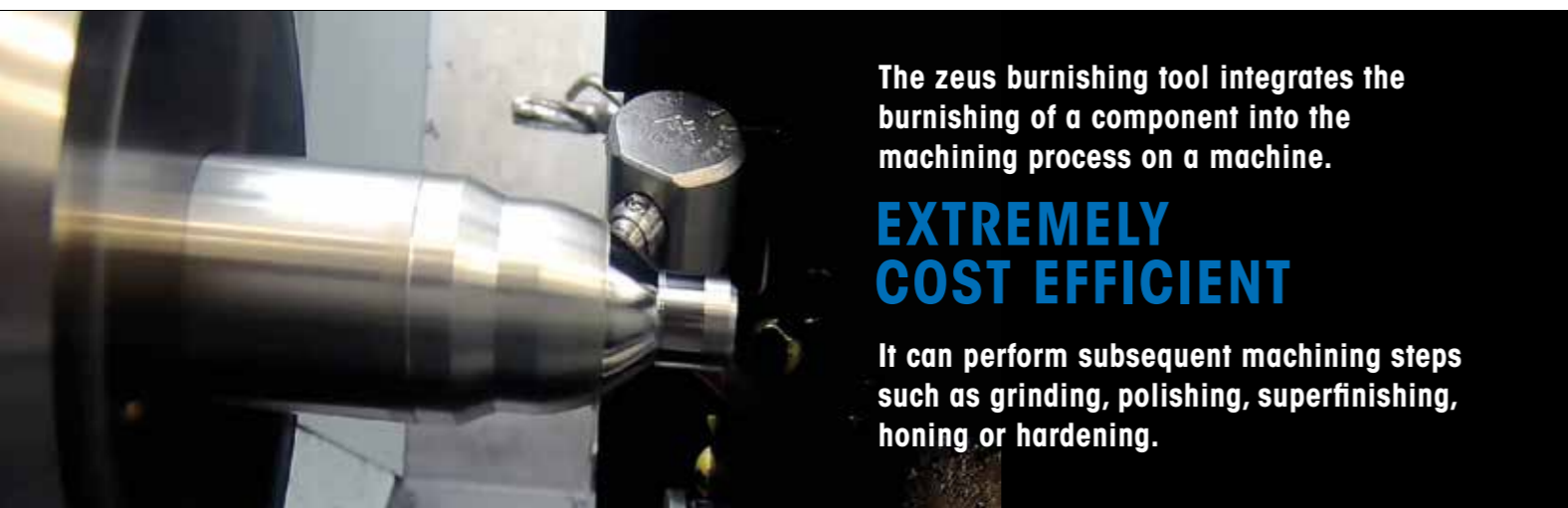
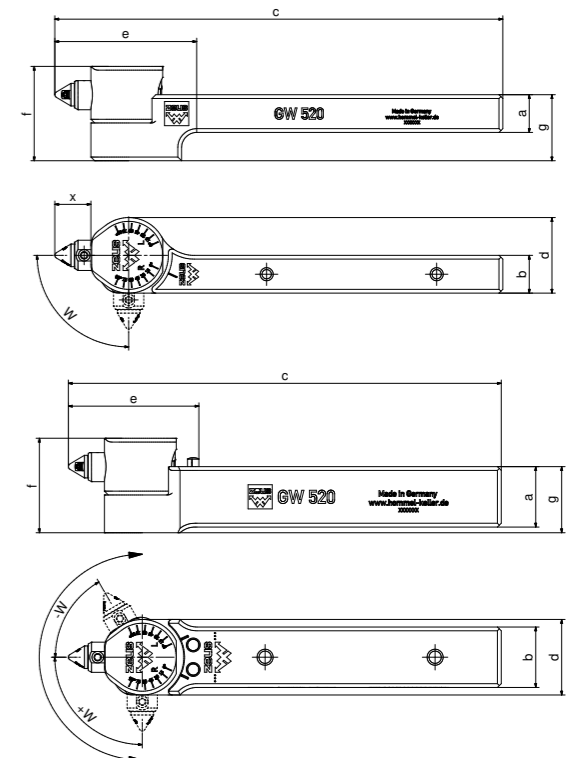

The zeus burnishing tool integrates the burnishing of a component into the machining process on a machine.

EXTREMELY COST EFFICIENT

It can perform subsequent machining steps such as grinding, polishing, superfinishing, honing or hardening.



BURNISHING ROLLS

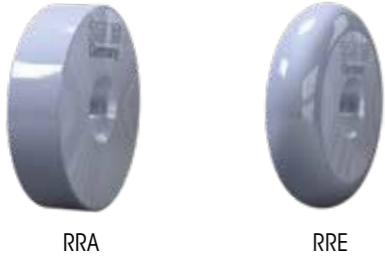

RRA

RRE

zeus burnishing rolls can be used in standard zeus form knurling tools. On request, we can develop and produce a custom holding system.

Use in this tool system is suitable for machining cylindrical work-pieces, bores, end faces, conical workpieces and for convex and concave outer contours.

Applications:

zeus burnishing rolls are used primarily for roller-burnishing and supporting round material during machining on lathes.

Result:

- Improved surface quality
- Increased dimensional stability
- Increased hardness of surfaces

Advantages:

- Burnished workpieces exhibit low friction and increased resistance to corrosion after machining
- Reworking, such as grinding, honing and lapping can be replaced by simple roller-burnishing machining
- When used as support rolls, they reduce wear on the bearings and clamping devices and minimise the pressure on the workpiece

Burnishing roll type RRA – cylindrical

Item no.	Rz-Class	Profile	Ø (mm)	Width (mm)	Bore (mm)	Bore fit
41020520	4	RRA	10	4	4	G7
41000000	5	RRA	10	4	4	G7
41020521	6	RRA	10	4	4	G7
41020522	4	RRA	15	4	4	G7
41000012	5	RRA	15	4	4	G7
41020523	6	RRA	15	4	4	G7
41020524	4	RRA	20	8	6	G7
41000045	5	RRA	20	8	6	G7
41020525	6	RRA	20	8	6	G7
41000055	4	RRA	25	8	6	G7
41020588	5	RRA	25	8	6	G7
41020526	6	RRA	25	8	6	G7

Rz-Class on the roll:

- No. 04: Rz 4 µm
- No. 05: Rz 2-3 µm
- No. 06: Rz 1 µm

Burnishing roll type RRE – convex

Item no.	Rz-Class	Profile	Ø (mm)	Width (mm)	Bore (mm)	Bore fit
41000006	4	RRE	10	4	4	G7
41020589	5	RRE	10	4	4	G7
41020527	6	RRE	10	4	4	G7
41000020	4	RRE	15	4	4	G7
41020590	5	RRE	15	4	4	G7
41019677	6	RRE	15	4	4	G7
41020528	4	RRE	20	8	6	G7
41000047	5	RRE	20	8	6	G7
41020529	6	RRE	20	8	6	G7
41000057	4	RRE	25	8	6	G7
41020591	5	RRE	25	8	6	G7
41020530	6	RRE	25	8	6	G7

Rz-Class on the roll:

- No. 04: Rz 4 µm
- No. 05: Rz 2-3 µm
- No. 06: Rz 1 µm

Technology Knurling Tools



Features

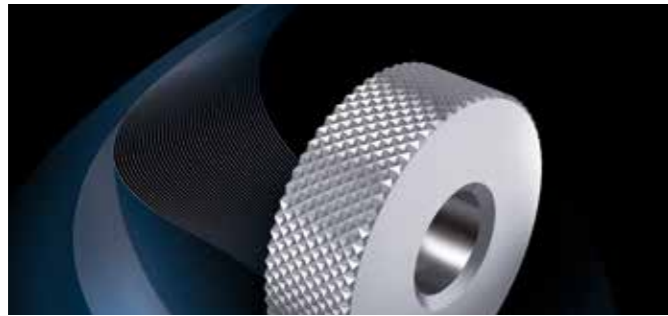

Advantages:

- Longer tool life
- Reduction of tool costs
- Reduction of set-up costs

In addition to the standard variants of powder metal, HSS, and carbide versions are also available on request.

zeus Premium materials

As your supplier of premium tool products we insist on materials that allow machining of hard-to-machine and pressure resistant materials. All knurling wheels in the standard zeus product line are therefore made of power metal.

The material features high hot hardness and compression strength, as well as durability and resistance to wear.

Surface treatment

Suitable treatment based on your individual application can have a positive effect on the life of the knurling wheel. We offer different treatment processes.

TENIFER® salt-bath nitriding heat treatment

Treatment of the knurling wheel in a salt bath based on the TENIFER® process increases the resistance to wear and the fatigue strength. The salt-bath nitrocarburising process achieves a high case hardness.

PVD coatings

Suitable PVD coating of the knurling wheels offers the user additional possibilities for increasing tool life. These variants are available on request. PVD coatings are suitable primarily for cut knurling applications.

Polished knurling wheels

The use of finely polished knurling wheels can be effective for machining of adhesive materials that require optimal chip sliding. This process achieves very smooth surfaces, with a low coefficient of friction. Edge radiusing on the tooth flanks prevents built-up edges from forming and therefore premature tooth breakage.



Profiles and knurling pitches

DIN 403 describes and specified the knurling profile on the knurling wheel. DIN 403 defines knurling forms AA, BL, BR, GE, GV, KE and KV. Knurling wheels that deviate from DIN 403 are considered special knurling tools and are custom manufactured by Hommel+Keller based on customer drawings.

AA Knurling wheel with axially parallel grooves

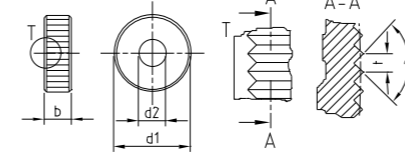

BL Left-hand knurling wheel

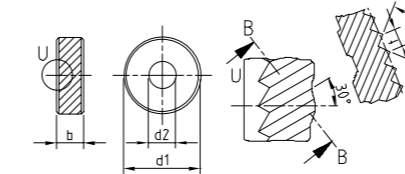

BR Right-hand knurling wheel

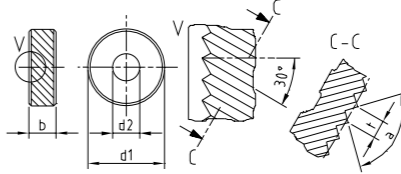

GE Left / right-hand knurling wheel, raised points, 30°

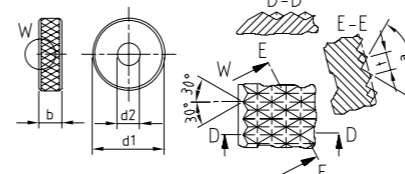

GV Left / right-hand knurling wheel, lowered points, 30°

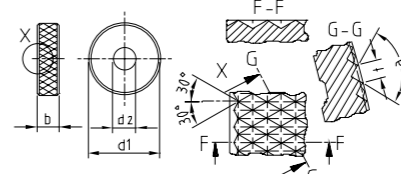

KE Cross knurling wheel, raised points, 90°

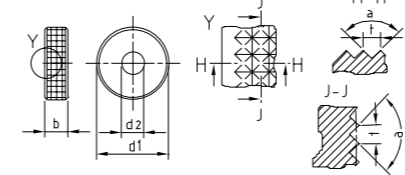

KV Cross knurling wheel, lowered points, 90°

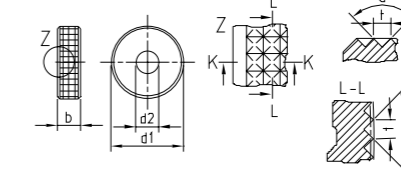

The knurling profile on the knurling wheel according to DIN 403 is based on the desired knurling profile on the workpiece (DIN 82) and the tool holder that is used.

The knurling pitch p refers to the distance between tooth crests. The pitches = 0.5 / 0.6 / 0.8 / 1.0 / 1.2 / 1.6 are standardised according to DIN 403. The Hommel+Keller product spectrum includes other pitches as well. They are listed below in mm and TPI. Other pitches are available as custom manufactured versions.

Conversion to inches

Knurling based on CP (TPI) and DP

■ CP (TPI) = Circular Pitch (Teeth Per Inch)

This standard specifies the number of teeth over a distance of 1 inch (1~25.4 mm). To calculate the pitch, divide 1 inch by the number of teeth. The profile angle is defined as 70° or 90°, depending on the number of teeth per inch.

Conversion example:

Specification CP (TPI) = 20

Pitch (mm) =
1 inch (~25.4 mm) : 20 (number of teeth) = 1.27 mm

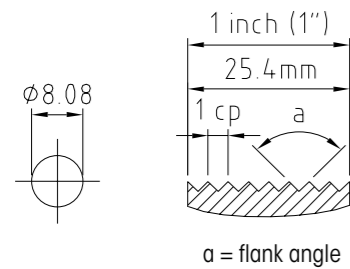

■ DP = Diametral Pitch

As opposed to CP (TPI) this standard specifies the number of teeth on the circumference of a circle with a diameter of 1 inch (1"~25.4 mm). To calculate the pitch, divide the circumference of a 1 inch circle by the number of teeth. The profile angle is defined as 80°.

Conversion example:

Specification DP = 64

Pitch (mm) =
1 inch (~25.4) x π (3.14...) : 64 (number of teeth) = 1.25 mm

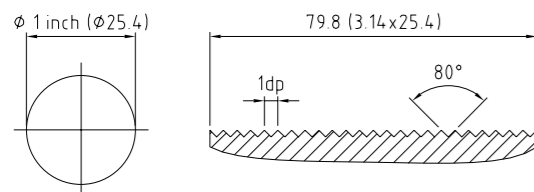

Process characteristics

Form knurling

Knurl profiles on
DIN 82 workpiece

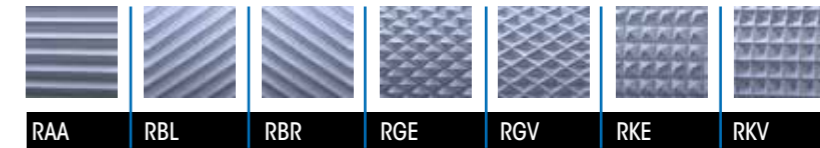

Application:

- Non-cutting forming
- Processing of workpieces suitable for cold forming
- All knurling forms and profiles can be manufactured
- Suitable for face and knurling within a bore
- Knurling up to a shoulder is possible
- Tool can be started at any location on the workpiece

Handling:

- Only minimal preparation of workpiece required
- Very easy handling of tool (short setup times)

Features:

- Material displacement increases the outer diameter of the workpiece
- The surface is compacted
- Form knurling of small diameters is possible only to a limited extent

Cut knurling

Knurl profiles on
DIN 82 workpiece

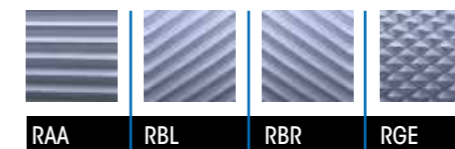

Application:

- Alternative cutting process
- Material removal at axial feed drive
- Machining of thin-walled, soft and hard-to-machine materials is possible
- Only cylindrical workpieces can be machined in axial direction
- Machining of small diameters is possible
- Maximum precision and surface quality, therefore suitable primarily for visible knurling
- A plunge cut is necessary for applying the tool in the middle area of the workpiece
- Knurling up to a shoulder is not possible

Handling:

- Requires precise tool adjustment and fine adjustment
- Requires precise preparation of the workpiece

Features:

- Minimal change in the outer diameter
- Minimal surface compaction
- Lower strain on machine than in form knurling
- Minimum pressure on the workpiece and machine

Material displacement – non-cutting forming

Our empirical values for enlargement of the workpiece diameter

Knurling profile acc. to DIN 82: RAA (knurling profile on workpiece)
 Knurling wheels according to DIN 403: AA (knurling profile on knurling wheel)

Pitch [mm]		0.3	0.4	0.5	0.6	0.7	0.8	1.0	1.2	1.5	1.6	2.0
Material	Workpiece Ø [mm]	Enlargement of workpiece diameter in mm										
Free-cutting steel	5	0.08	0.14	0.18	0.22	0.27	0.29	0.35	0.50	–	–	–
	15	0.08	0.14	0.18	0.23	0.30	0.40	0.44	0.50	0.60	0.65	0.70
	25	0.08	0.15	0.23	0.24	0.28	0.35	0.44	0.53	0.62	0.70	0.98
Stainless steel	5	0.10	0.15	0.20	0.25	0.28	0.30	0.42	0.41	–	–	–
	15	0.10	0.15	0.19	0.25	0.30	0.34	0.45	0.51	0.60	–	–
	25	0.10	0.14	0.20	0.26	0.31	0.33	0.43	0.50	0.62	–	–
Brass	5	0.08	0.12	0.18	0.20	0.21	0.22	0.25	0.28	–	–	–
	15	0.10	0.14	0.20	0.26	0.28	0.29	0.35	0.41	0.44	0.48	0.55
	25	0.10	0.15	0.20	0.25	0.28	0.30	0.36	0.43	0.46	0.50	0.53
Aluminium	5	0.09	0.15	0.19	0.23	0.28	0.30	0.41	0.40	–	–	–
	15	0.10	0.15	0.19	0.26	0.29	0.33	0.45	0.51	0.57	0.65	–
	25	0.09	0.15	0.19	0.26	0.29	0.32	0.45	0.52	0.59	0.65	0.75

Knurling profile acc. to DIN 82: RBL30°/RBR30° (knurling profile on workpiece)
 Knurling wheels according to DIN 403: BR30°/BL30° (knurling profile on knurling wheel)

Pitch [mm]		0.3	0.4	0.5	0.6	0.7	0.8	1.0	1.2	1.5	1.6	2.0
Material	Workpiece Ø [mm]	Enlargement of workpiece diameter in mm										
Free-cutting steel	5	0.11	0.15	0.20	0.24	0.28	0.34	0.45	0.55	–	–	–
	15	0.11	0.15	0.22	0.26	0.30	0.35	0.45	0.52	0.67	0.73	0.85
	25	0.11	0.14	0.23	0.25	0.28	0.36	0.45	0.56	0.70	0.72	0.90
Stainless steel	5	0.09	0.14	0.19	0.25	0.31	0.34	0.45	0.52	–	–	–
	15	0.12	0.20	0.23	0.31	0.35	0.40	0.51	0.62	0.66	0.73	0.97
	25	0.12	0.18	0.24	0.27	0.37	0.39	0.49	0.59	0.80	0.84	0.96
Brass	5	0.10	0.14	0.20	0.23	0.24	0.28	0.33	0.37	–	–	–
	15	0.10	0.15	0.21	0.23	0.24	0.31	0.41	0.47	0.53	0.55	0.63
	25	0.11	0.15	0.22	0.22	0.25	0.30	0.40	0.45	0.55	0.61	0.68
Aluminium	5	0.12	0.14	0.21	0.24	0.29	0.34	0.41	0.51	–	–	–
	15	0.12	0.18	0.23	0.26	0.36	0.40	0.50	0.56	0.56	0.61	0.75
	25	0.12	0.18	0.25	0.28	0.37	0.39	0.50	0.58	0.77	0.82	0.96

Knurling profile acc. to DIN 82: RGE30° (knurling profile on workpiece)
 Knurling wheels according to DIN 403: BR30°/BL30° (knurling profile on knurling wheel)

Pitch [mm]		0.3	0.4	0.5	0.6	0.7	0.8	1.0	1.2	1.5	1.6	2.0
Material	Workpiece Ø [mm]	Enlargement of workpiece diameter in mm										
Free-cutting steel	5	0.12	0.16	0.20	0.25	0.33	0.41	0.55	0.65	–	–	–
	15	0.13	0.22	0.30	0.32	0.35	0.41	0.52	0.62	0.67	0.81	0.95
	25	0.12	0.18	0.28	0.32	0.35	0.38	0.55	0.67	0.77	0.87	0.98
Stainless steel	5	0.11	0.20	0.25	0.30	0.36	0.39	0.55	0.55	–	–	–
	15	0.10	0.14	0.21	0.24	0.29	0.34	0.43	0.53	0.66	0.72	0.88
	25	0.11	0.13	0.20	0.25	0.28	0.32	0.44	0.52	0.67	0.70	0.83
Brass	5	0.12	0.13	0.16	0.20	0.24	0.28	0.32	0.38	–	–	–
	15	0.12	0.16	0.18	0.24	0.28	0.30	0.39	0.40	0.48	0.52	0.63
	25	0.12	0.17	0.22	0.23	0.27	0.30	0.38	0.41	0.48	0.50	0.63
Aluminium	5	0.10	0.15	0.21	0.25	0.33	0.36	0.50	0.57	–	–	–
	15	0.11	0.14	0.20	0.25	0.28	0.33	0.43	0.54	0.67	0.71	0.89
	25	0.11	0.15	0.22	0.25	0.29	0.34	0.44	0.53	0.68	0.69	0.88

Reference values for cutting speed and feed rate

Form knurling – non-cutting process

Material	Workpiece Ø [mm]	Knurling wheel Ø [mm]	Vc [m/min]		f [mm/U]					
					Radial		Axial			
			from	to	from	to	>0.3 < 0.5	>0.5 < 1.0	>1.0 < 1.5	>1.5 < 2.0
Free-cutting steel	< 10	10/15	20	50	0.04	0.08	0.14	0.09	0.06	0.05
	10 - 40	15/20	25	55	0.05	0.10	0.20	0.13	0.10	0.07
	40 - 100	20/25	30	60	0.05	0.10	0.25	0.18	0.12	0.08
	100 - 250	20/25	30	60	0.05	0.10	0.30	0.20	0.13	0.09
Stainless steel	< 10	10/15	15	40	0.04	0.08	0.12	0.08	0.05	0.04
	10 - 40	15/20	20	50	0.05	0.10	0.17	0.11	0.09	0.06
	40 - 100	20/25	25	50	0.05	0.10	0.21	0.15	0.10	0.07
	100 - 250	20/25	25	50	0.05	0.10	0.26	0.17	0.11	0.08
Brass	< 10	10/15	30	75	0.04	0.08	0.15	0.09	0.06	0.05
	10 - 40	15/20	40	85	0.05	0.10	0.21	0.14	0.11	0.07
	40 - 100	20/25	45	90	0.05	0.10	0.26	0.19	0.13	0.08
	100 - 250	20/25	45	90	0.05	0.10	0.32	0.21	0.14	0.09
Aluminium	< 10	10/15	25	60	0.04	0.08	0.18	0.11	0.08	0.06
	10 - 40	15/20	30	65	0.05	0.10	0.25	0.16	0.13	0.09
	40 - 100	20/25	35	70	0.05	0.10	0.31	0.23	0.15	0.10
	100 - 250	20/25	35	70	0.05	0.10	0.38	0.25	0.16	0.11
Free-cutting steel	> 250	25	45	90	0.05	0.10	0.34	0.22	0.15	0.11
	> 250	25	45	90	0.05	0.10	0.40	0.26	0.18	0.13

Cut knurling – cutting process

Material	Workpiece Ø [mm]	Knurling wheel Ø [mm]	Vc [m/min]		f [mm/U]					
					Radial		Axial			
			from	to	from	to	>0.3 < 0.5	>0.5 < 1.0	>1.0 < 1.5	>1.5 < 2.0
Free-cutting steel	< 10	10/15	40	70	0.04	0.08	0.20	0.13	0.08	0.07
	10 - 40	15/25	50	90	0.05	0.10	0.28	0.18	0.14	0.10
	40 - 100	25/32/42	65	110	0.05	0.10	0.35	0.25	0.17	0.11
	100 - 250	25/32/42	65	110	0.05	0.10	0.42	0.28	0.18	0.13
Stainless steel	< 10	10/15	22	40	0.04	0.08	0.14	0.09	0.06	0.05
	10 - 40	15/25	30	50	0.05	0.10	0.20	0.13	0.10	0.07
	40 - 100	25/32/42	35	60	0.05	0.10	0.25	0.18	0.12	0.08
	100 - 250	25/32/42	35	60	0.05	0.10	0.29	0.20	0.13	0.09
Brass	< 10	10/15	55	100	0.04	0.08	0.22	0.14	0.09	0.08
	10 - 40	15/25	70	125	0.05	0.10	0.31	0.20	0.15	0.11
	40 - 100	25/32/42	90	155	0.05	0.10	0.39	0.28	0.18	0.12
	100 - 250	25/32/42	90	155	0.05	0.10	0.46	0.31	0.20	0.14
Aluminium	< 10	10/15	70	120	0.04	0.08	0.12	0.08	0.05	0.04
	10 - 40	15/25	80	150	0.05	0.10	0.17	0.11	0.08	0.06
	40 - 100	25/32/42	110	160	0.05	0.10	0.21	0.15	0.10	0.07
	100 - 250	25/32/42	110	160	0.05	0.10	0.25	0.17	0.11	0.08
Free-cutting steel	> 250	32/42	130	150	0.05	0.10	0.27	0.18	0.12	0.08

!
Important notice:
 This information represents empirical values. Deviations are possible.

!
Important notice:
 This information represents reference values. The optimal values are to be found in the application. Ensure effective cooling/lubrication to prevent chips from being rolled into the profile and to prolong the life of the knurling wheels.

Influencing factors

Clearance dimensions / plunge cut for cut knurling

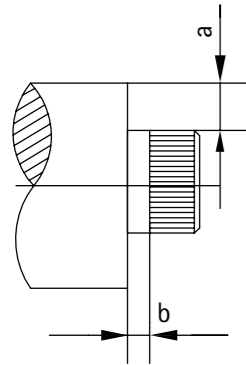

Clearance dimension for cut knurling – workpiece collar

Due to the design-related inclination (30°) of the knurling head and the overhang of the cover plate, knurling up to a collar is not possible with a cut knurling tool.

Dimension a corresponds to the increase in the step (mm). Dimension b corresponds to the minimum clearance for the respective knurling wheel (Ø specified in mm).

Dimension a is calculated with shoulder-height and 1/2 pitch with a flank angle of 90°.

Maß „a“ [mm]	b 10 x 3 x 6 mm	b 15 x 4 x 8 mm	b 25 x 6 x 8 mm	b 42 x 13 x 16 mm
1	1.3	1.5	2	3
3	2.7	4.2	3.2	5
5	3	4.9	4.5	7
7	3	5.2	5.5	9
10	3	5.2	6.7	12
12	3	5.2	7	12

Dimension a = shoulder-height + 1/2 pitch (flank angle 90°).

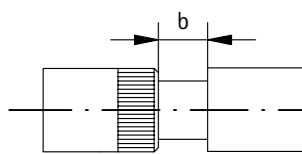

Minimum width of the plunge cut – cut knurling

If knurling is to be applied in the middle of the workpiece, a “knurling undercut” is needed (the knurling wheel requires a chamfer for centring).
Depth of the plunge cut: at least 1/2 pitch + 0.3 mm.

Maß Rändelräder [mm]	10 x 3 x 6 mm	15 x 4 x 8 mm	25 x 6 x 8 mm	42 x 13 x 16 mm
Minimum width of plunge (b)	3 mm	4 mm	6.5 mm	14 mm

Influencing factors

Factors affecting quality and process reliability during knurling

Numerous factors must be taken into account and optimised in order to manufacture a high-quality and functional knurling profile.

The factors listed below are crucial for process reliability, quality, precision and surface quality and should be taken into account in order to optimise the application.

Tool properties	Quality and specification of the knurling wheel	Knurl width	PVD coating TENIFER®		
		Knurling wheel with chamfer			
		Material properties		Base material for the knurling wheel	
				Hardness of the knurling wheel	
		Reworking			
	Precision	Run-out accuracy	Sharpness of tooth crest Radius in tooth gullet Flank angle		
		Concentricity			
		Profile properties			
	Type of tool holder used	Type of knurling process	Form knurling	Plunge knurling Feed knurling	
			Cut knurling	Plunge / feed knurling	
Quality and condition of the axle pin / bearing bush		Stability / freedom from vibration	Precision		
				Maschinen-eigenschaften	Precision
					Stability / freedom from vibration
Properties of the material to be machined	Cutting values	Feed rate			
			Plunge depth		
			Cooling / lubrication	Cutting speed	
			Clearance angle		
	Quality of teeth	Rough-turn diameter	Material distortion		
		Pitch / number of teeth			

Optimization of knurling

The pitch corresponds to the workpiece circumference

In many cases the user does not notice the relationship between the pitch and the workpiece circumference, since the pitch already corresponds to the workpiece circumference. The knurling wheel can compensate the distortion of the pitch to produce good knurling (see Figure 1).

The pitch does not optimally correspond to the workpiece circumference

The more unfavourable the pitch corresponds to the workpiece circumference, the more the knurling wheel has to compensate. This results in knurling of poor quality and reduces the tool life.

Effects on the knurling quality:

Form knurling:

The less favourable forming process (unnecessary strain on the material) results in a rough surface and reduced tool life. The sub-optimal penetration process causes material abrasion, which is formed into the knurling profile (indistinct profile flanks). This results in distortions of the knurling profile, which are evident in flattening of the profile and rounding of the tooth crest and tooth gullet (see Figure 2).

Cut knurling:

The sub-optimal penetration process of the knurling wheel results in indistinct profile flanks (shadowing). This results in distortions of the knurling profile, which are evident in flattening of the knurling profile and rounding of the tooth crest and tooth gullet (see Figure 2).

The pitch does not correspond to the workpiece circumference

This is an extreme case. The knurling wheel cannot compensate the unfavourable relationship between the pitch and the workpiece circumference, or the profile is heavily distorted.

In the worst case this can result in "double knurling". The knurling wheel then no longer engages in the knurling profile after one workpiece rotation, but instead engages between the profile.

This is evident in the finer pitch of the knurling (see Figure 3).

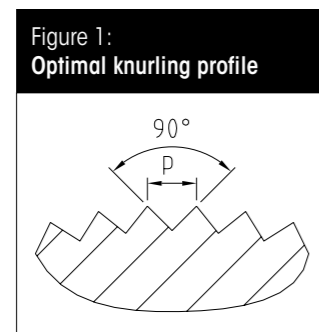

p = pitch

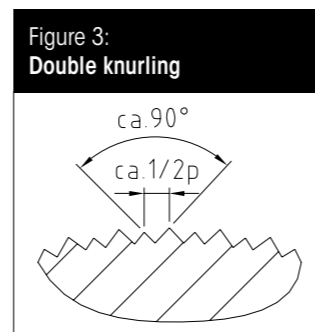
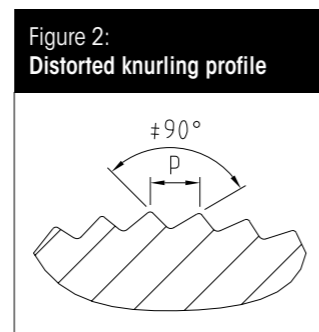

Optimization of knurling

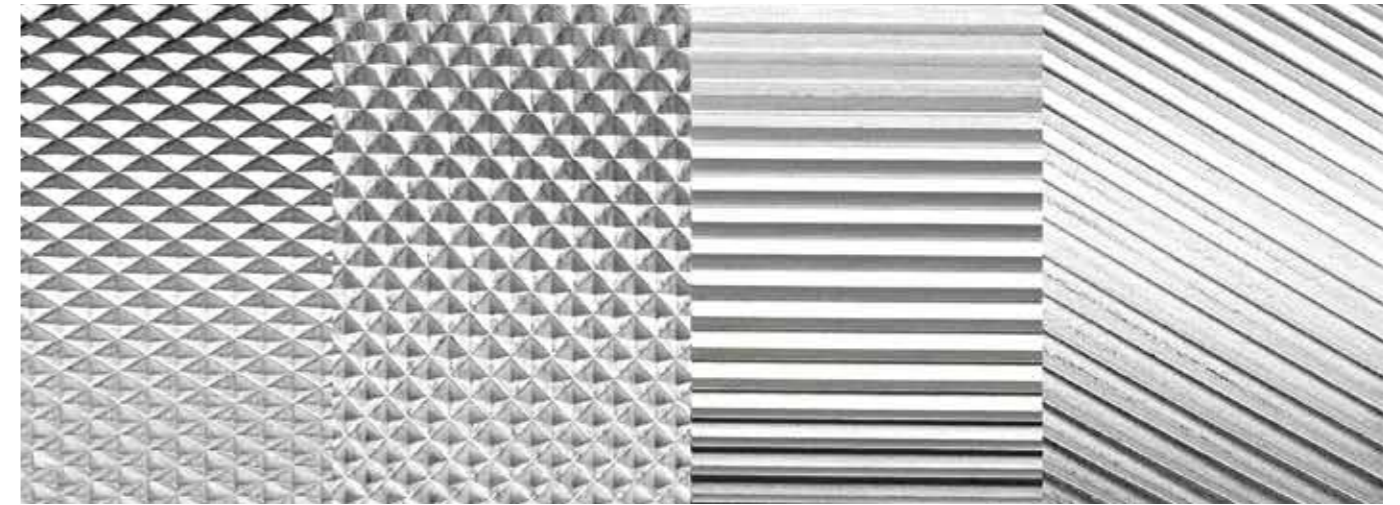

The knurling quality and the tool life can be improved substantially by optimising the knurling by changing the rough-turn diameter and/or the pitch.

The following procedure ensures systematic optimisation:

- Correction of the rough-turn diameter until optimal knurling is achieved.

Note:

Changing the rough-turn diameter by only a few hundredths of a millimetre has a substantial effect on the circumference {factor π ($\times 3.14\dots$)} and can change the knurling quality significantly.

If a correction is not possible (tolerances cannot be maintained; workpiece diameter should not be turned), then:

- Check whether the pitch can be changed.

If it is not possible to change the pitch, it is necessary to manufacture a special knurling wheel with optimised pitch (defined number of teeth/outer diameter of knurling wheel).

Consultation is provided by the Hommel+Keller application engineer on the basis of a workpiece drawing and information about the machine.

The calculation of the optimal pitch is conducted on the basis of approximate formulas. Due to influencing factors (such as differences in materials) further optimisation may be necessary.

Summary:

Customer requirements:

- Clear, distinct knurling profile
- Fully formed teeth
- No double knurling/no incomplete knurling

Solutions:

1) Optimisation measures by user:

- Correction of the rough-turn diameter
- Change of the pitch

2) Optimisation measures by Hommel+Keller:

- Optimisation by manufacturing a special knurling wheel:
- Calculation of the number of teeth allows development of a knurling wheel that is specially designed for the application based on the optimal relationship between the diameter and the number of teeth.

Technology Marking tools

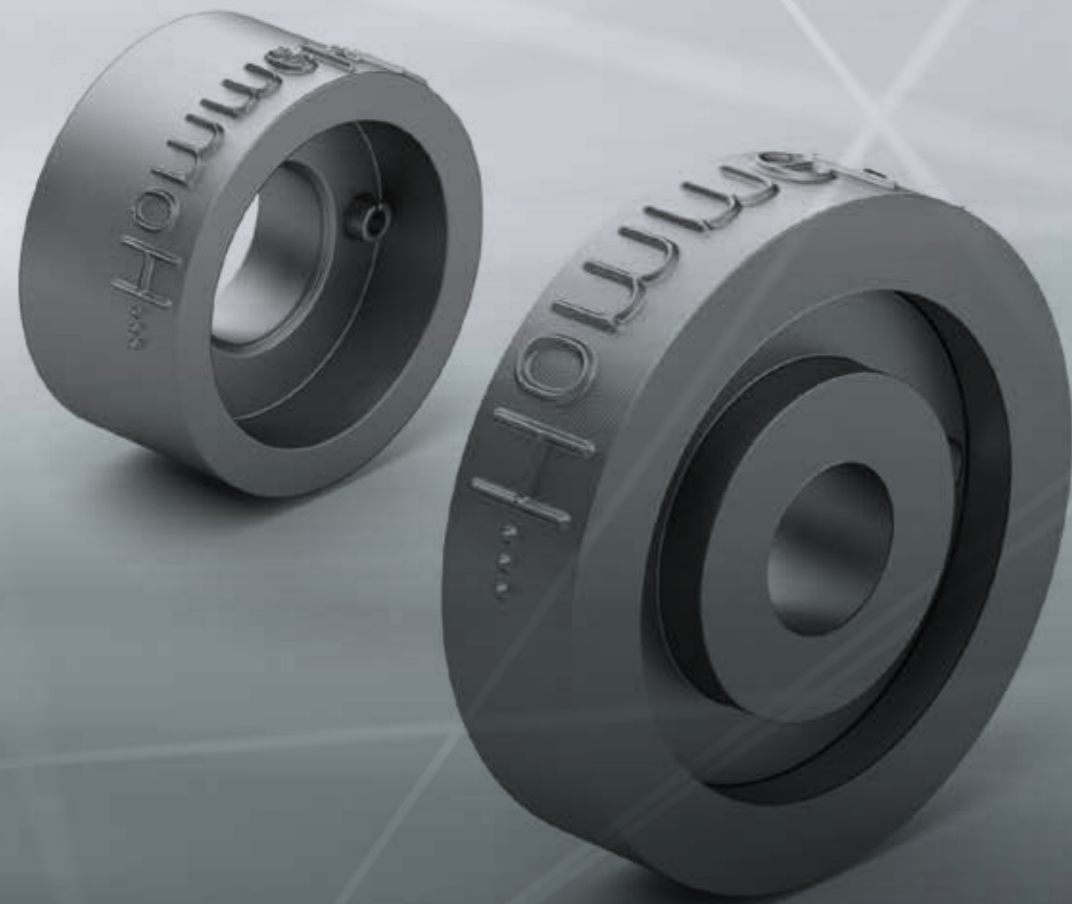

On www.hommel-keller.de you will find videos on the subject of marking technology. Convince yourself of our marking tools.

Important information

Guidelines for process parameters

System	Material	Workpiece Ø	Speed n [rpm]	Feed rate, radial f [mm/U]	Impression depth (PT) a_p value [mm]*
Revolving	up to max. $R_m = 1000 \text{ N/mm}^2$	Any	200	0.08	$r = 0.075$ $\varnothing = 0.15$
Spring-return	up to max. $R_m = 1000 \text{ N/mm}^2$	Any	200 Unwinding via C-axis is possible	$f = d \times \pi$ (d = workpiece diameter) High speed (possible with restrictions)	$r = 0.075$ $\varnothing = 0.15$

! The values provided here are recommendations (base values) and must be optimised for the application.

* The impression depth must always be greater than the concentricity ($\varnothing 0.03 \text{ mm}$).

The embossing quality and the wear of the marking rolls/segments is dependent on:

- the combination of workpiece diameter and speed
- the feed rate
- the material
- and the application (e.g. clamping set-up – single- or double-sided)

Surfaces for marking must be clean (free of surface contaminants) to ensure optimal driving of the segments and the marking roll. When marking in axial direction – spindle stop (speed = 0), feed rate in axial direction = feed rate in radial direction.

Spring-return system – start-up when stopped

1. Spindle at standstill
2. Infeed of tool to desired impression depth
3. Run spindle slowly
4. Return of tool

Explanation of marking roll designation

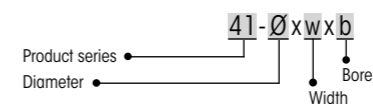

Shank adapter

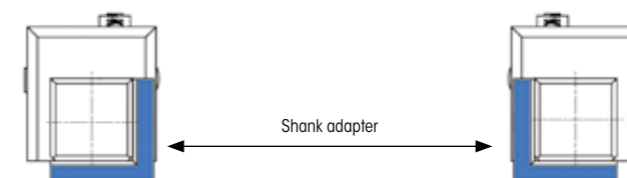

! With the modular tool sets 421 and 431 the adapter is used to change the shank size asymmetrically.

Technical specifications

1. Font

- The standard font is based on DIN 1451. (Other typefaces available on request.)
- A .dxf file is needed for logos and special characters.

2. Possible marking types | drives

2.1 Spring-return system

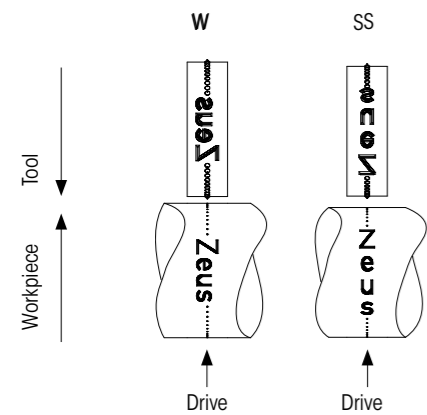

- In the standard version the drive is positioned on the centre of the marking roll/marketing segment.
- On request, the drive, which can be custom designed (logo, backlash, asterisks, number signs, etc.), can be applied to the side of the characters and removed afterwards by reworking (cutting off, finish machining, bevelling, etc.).

2.2 Revolving system

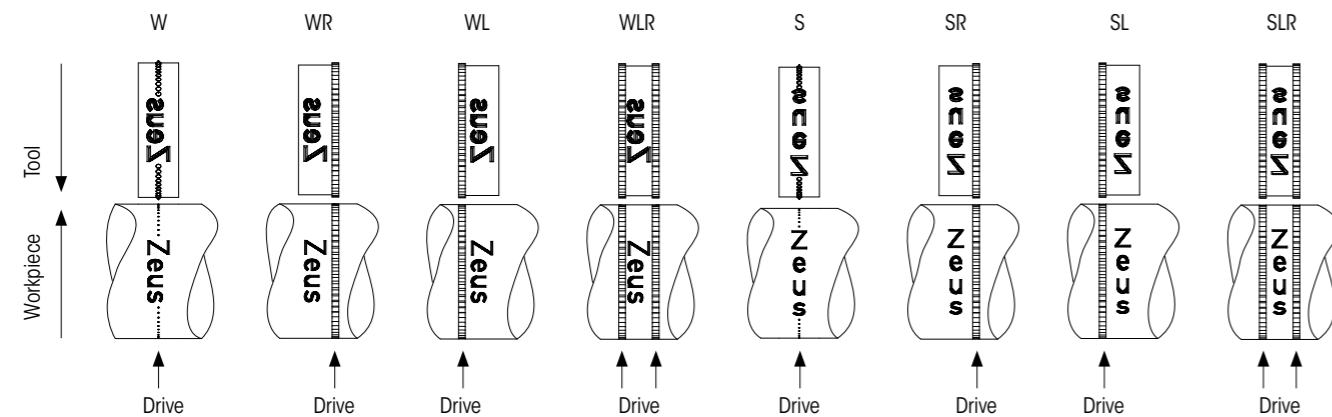

- To ensure continuous rotation of the tool, a drive is needed, which can be custom designed (logo, backlash, asterisks, number signs, etc.) and removed by means of reworking (cutting off, finish machining, bevelling, etc.).

3. Diameter ratio: Marking roll/segment and workpiece

3.2 Spring-return system

- The diameter of the marking roll / marking segment is **independent** on the workpiece diameter.

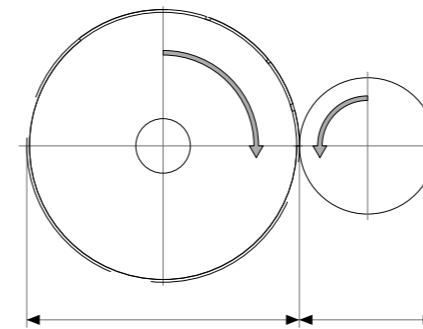

\emptyset Marking segment : \emptyset Workpiece
 $i = n : 1$

3.1 Revolving System

- The diameter of the marking roll is **dependent** on the workpiece diameter.

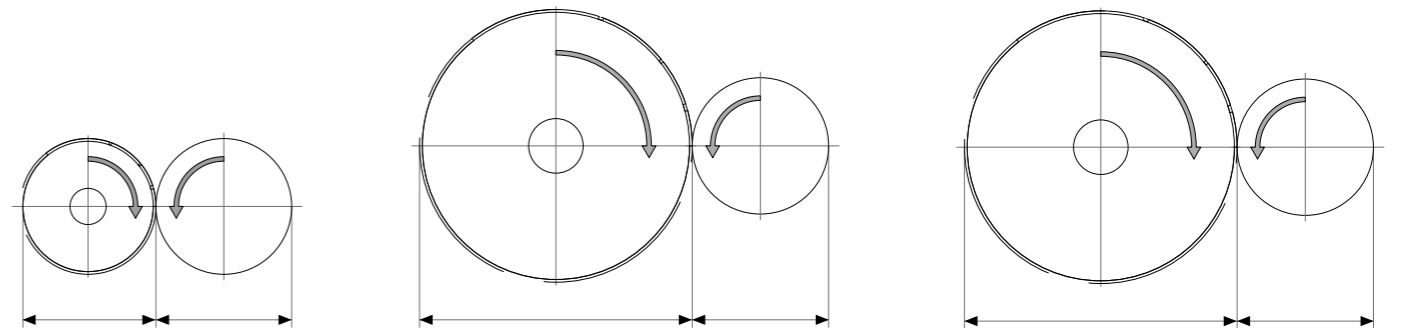

\emptyset Marking roll : \emptyset Workpiece
 $i = 1 : 1$

$i = 1$

\emptyset Marking roll : \emptyset Workpiece
 $i = n : 1$

$i > 1$

\emptyset Marking segment :
 $i = n : m$

4. Practical guidance

1. Preparation of workpiece

- The surface must be clean
- Perfect concentricity is essential (0.03 mm)
- The diameter of the workpiece must be very precise (max. tolerance: +/- 0.025 mm)

2. Impression depth

- The standard impression depth is 0.075 mm relative to the radius/ 0.15 mm relative to the diameter
- Impression depths exceeding the recommended maximum values may cause character distortions

3. Marking as part of the machining process

- The position of the drive on the workpiece should be taken into account during the machining process
- There is a danger that weak parts of the workpiece are deformed during marking. We recommend marking to be carried out on the strong parts of the workpiece and/or before the critical machining steps



a brand of
Hommel+Keller
Präzisionswerkzeuge GmbH



PRÄZISIONSWERKZEUGE

Hommel+Keller
Präzisionswerkzeuge GmbH
78554 Aldingen · Germany
Tel. +49 7424 9705-0
info@hommel-keller.de
www.hommel-keller.de